

*Roger Access Control System*

## Installation guide for HRT82MF-CH card holder

Firmware version: 1.0.2.16 or newer

Hardware version: 1.0

Document version: Rev. F

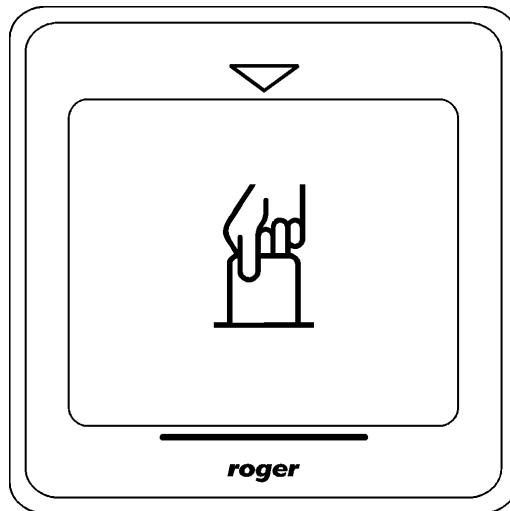

rcdr202

## 1. INTRODUCTION

This manual contains minimum information that is necessary to properly install device. Following documents supplement this manual:

- Functional description of HRC series controllers
- Installation guide for HRC series controllers

In order to acquire the first one it is necessary to obtain Roger consent and sign non-disclosure agreement (NDA). The second one is available at [www.roger.pl](http://www.roger.pl).

## 2. DESCRIPTION AND SPECIFICATION

HRT82MF-CH card holder is peripheral device used in a hotel system based on HRC series controllers. The device communicates with controller using RACS CLK/DTA bus and periodically reads card in its holder in order to enable monitoring of card owner presence (i.e. guest or hotel staff) in hotel room. Such monitoring can be used for 230VAC power supply switching, air conditioning and/or hotel automation control. The device enables serial number (CSN) reading for such cards as MIFARE® Ultralight/Classic/Plus/Desfire. Additionally it allows to read configurable Mad Sector Number (MAD) and Sector Serial Number (SSN) as well as combinations of CNS and MSN or SSN for MIFARE Classic cards.

HRT82MF-CH front panel includes card holder. The device is equipped with front panel backlight and buzzer. The device is offered in two versions: HRT82MF-CH for surface mounting and HRT82MF-CH-F for flush mounting.

<b>Table 1. Specification</b>	
Supply voltage	Nominal 12VDC, min./max. range 10-15VDC
Proximity cards	13.56MHz in acc. with ISO14443A and MIFARE
Reading distance	Up to 15 cm for ISO cards (depends on card type and quality)
Average current consumption	60mA
Tamper resistance	Isolated contact, NC type (normally closed when enclosure is assembled and attached), 24V/50mA
Distance	Between controller and HRT device (RACS CLK/DTA): max. 150m
Environmental class (acc. to EN 50131-1)	Class II, indoor general conditions, temperature: -10°C- +50°C, relative humidity: 10 to 95% (no condensation)
IP code	IP30
IK code	HRT82MF-CH: IK06 HRT82MF-CH-F: IK08
Dimensions HxWxD	HRT82MF-CH: 85 x 85 x 27 mm HRT82MF-CH-F: 105 x 105 x 36 mm
Weight	~ 100g
Certificates	CE

### 3. INSTALLATION

#### 3.1 Terminals and connection diagram

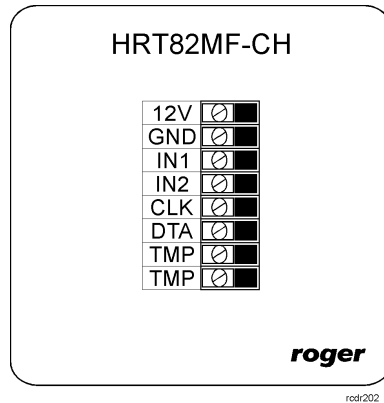

Fig. 1 HRT82MF-CH card holder

**Table 2. HRT82MF-CH terminals**

Term.	Description	Term.	Description
12V	12VDC power supply	CLK	RACS CLK/DTA bus
GND	Ground	DTA	RACS CLK/DTA bus
IN1	not used	TMP	Tamper
IN2	not used	TMP	Tamper

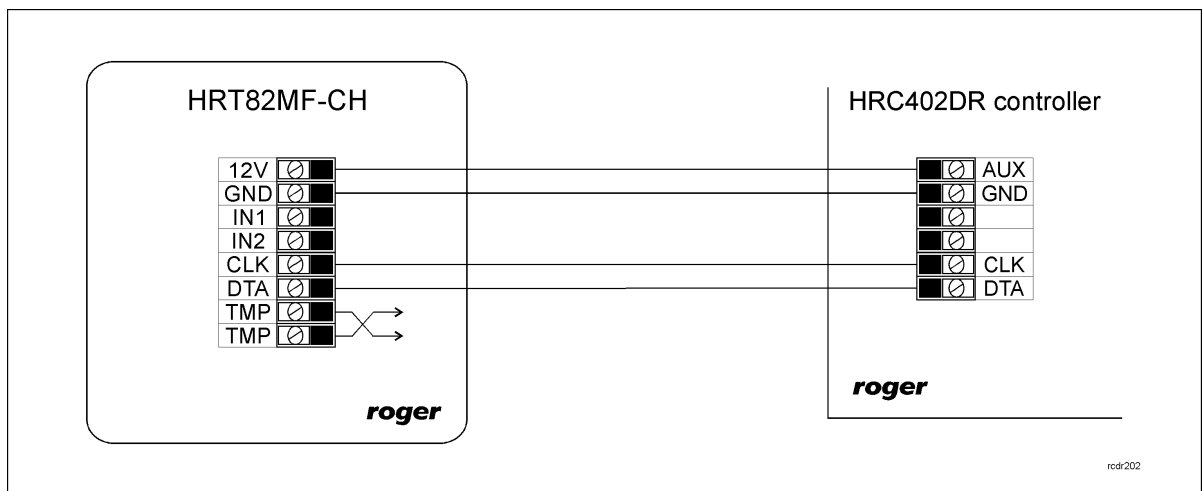

Fig. 2 Connection to controller with 12VDC power supply output

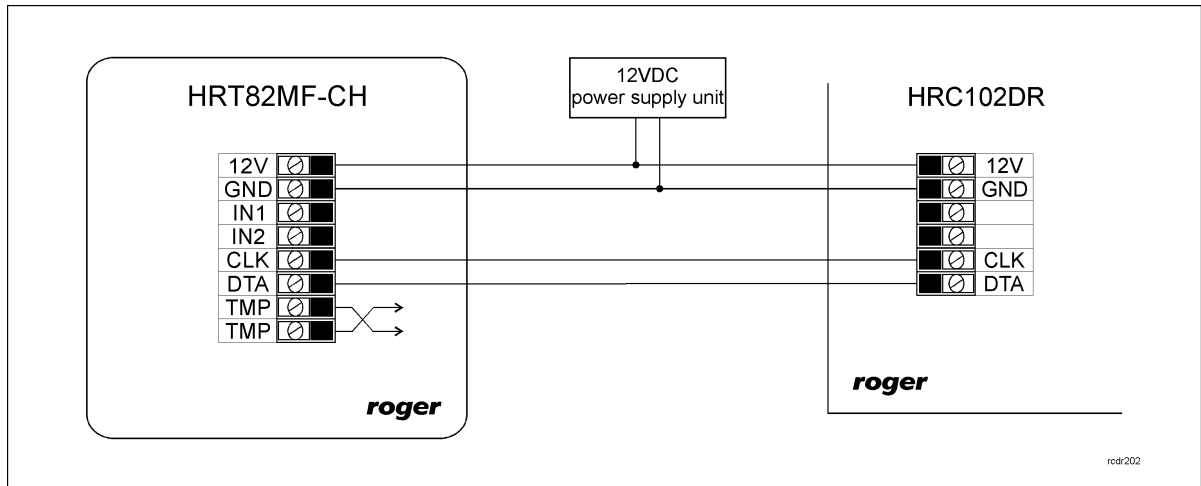

Fig. 3 Connection to controller without 12VDC power supply output

## 3.2 Power supply

HRT82MF-CH requires 12VDC nominal power supply. The power must be connected to 12V and GND terminals. Additionally, the GND terminal is used as reference potential for the RACS CLK/DTA bus. HRT82MF-CH power supply can be provided by connection to buffer power supply unit (e.g. PS-15DR, PS20) or connection to AUX output of HRC402DR controller (see fig. 2). Backup battery connected to power supply unit or directly to HRC402DR controller can be used in order to ensure operation in case of 230VAC power failure.

Note: All devices connected to the same RACS CLK/DTA bus must be connected to common reference potential (GND).

## 3.3 RACS CLK/DTA communication bus

RACS CLK/DTA is the addressable bidirectional communication standard developed and applied in Roger controllers in order to enable their communication with peripheral devices. Addresses of all devices connected to CLK and DTA lines must be properly configured in range of 00..15. Standard unshielded signal cables (e.g. U/UTP cat. 5) with maximal length of 150m can be used for RACS CLK/DTA communication.

## 3.4 Front panel

HRT82MF-CH front panel includes card holder. At the holder entry, white backlight is by default switched on and it is also possible to switch green and/or red light below the holder. This additional backlight can be switched by HRC series controller.

## 3.5 Wall mounting and installation guidelines

HRT82MF-CH consists of front panel and base which are factory assembled and require manual disassembly prior to installation according to fig. 4.

### Installation guidelines

- Install device on wall far from sources of heat and moisture
- It is recommended to install device on Ø60mm flush mounting box
- Front panel and base must be properly oriented in order to ensure functioning of tamper resistance.
- All electric connections must be made with power supply switched off
- Run connection wires through hole in device base and then connect wires to screw terminals
- If device and controller are supplied from different power supply units then it is necessary connect GND terminals of both devices
- Front panel can be regularly cleaned with wet cloth and mild detergent. Do not clean by means of abrasive materials and strong cleaners like alcohols, solvents, etc.

- Damages resulting from improper maintenance or use are not covered by warranty

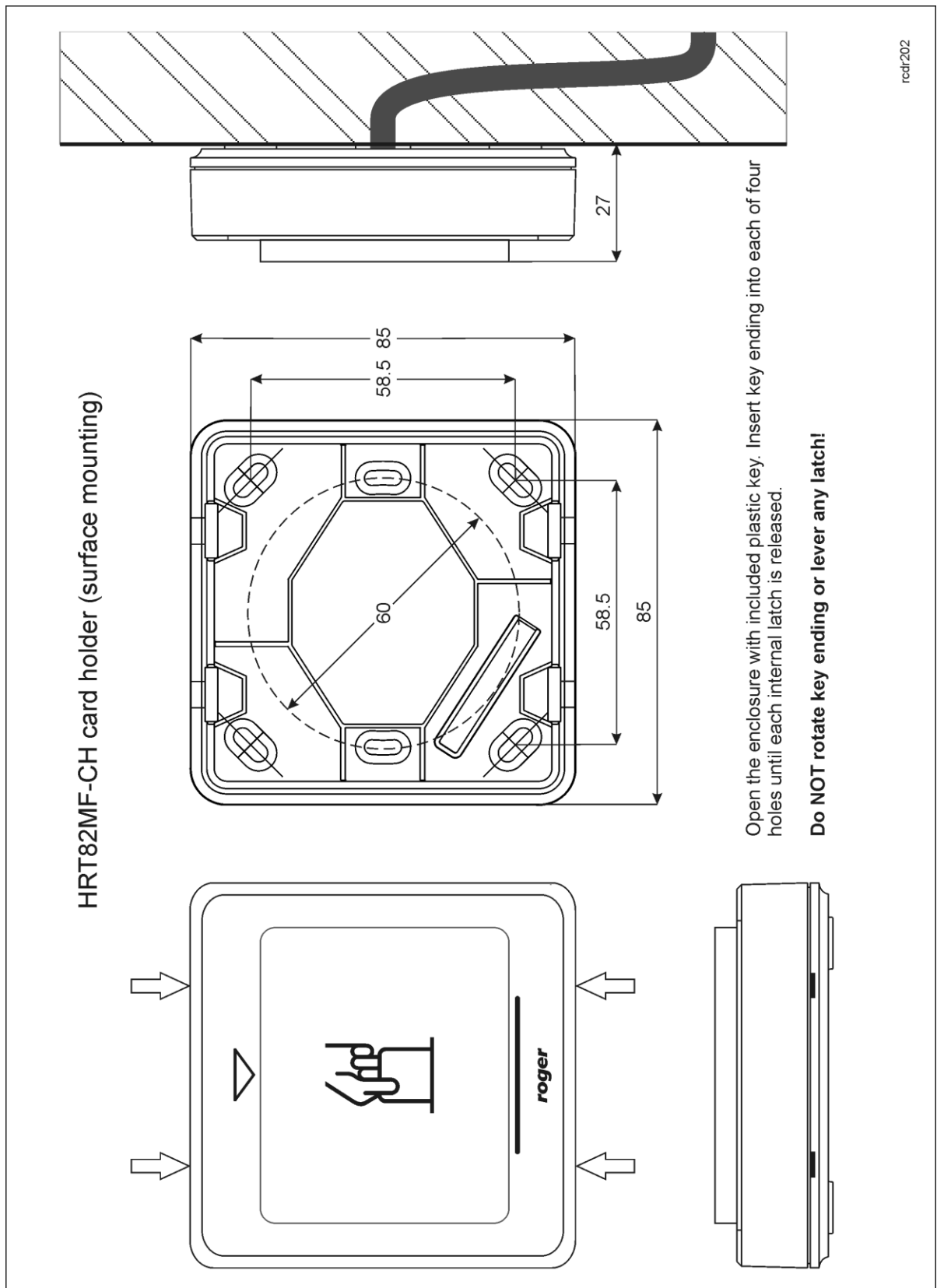

Fig.4 HRT82MF-CH latches and surface mounting

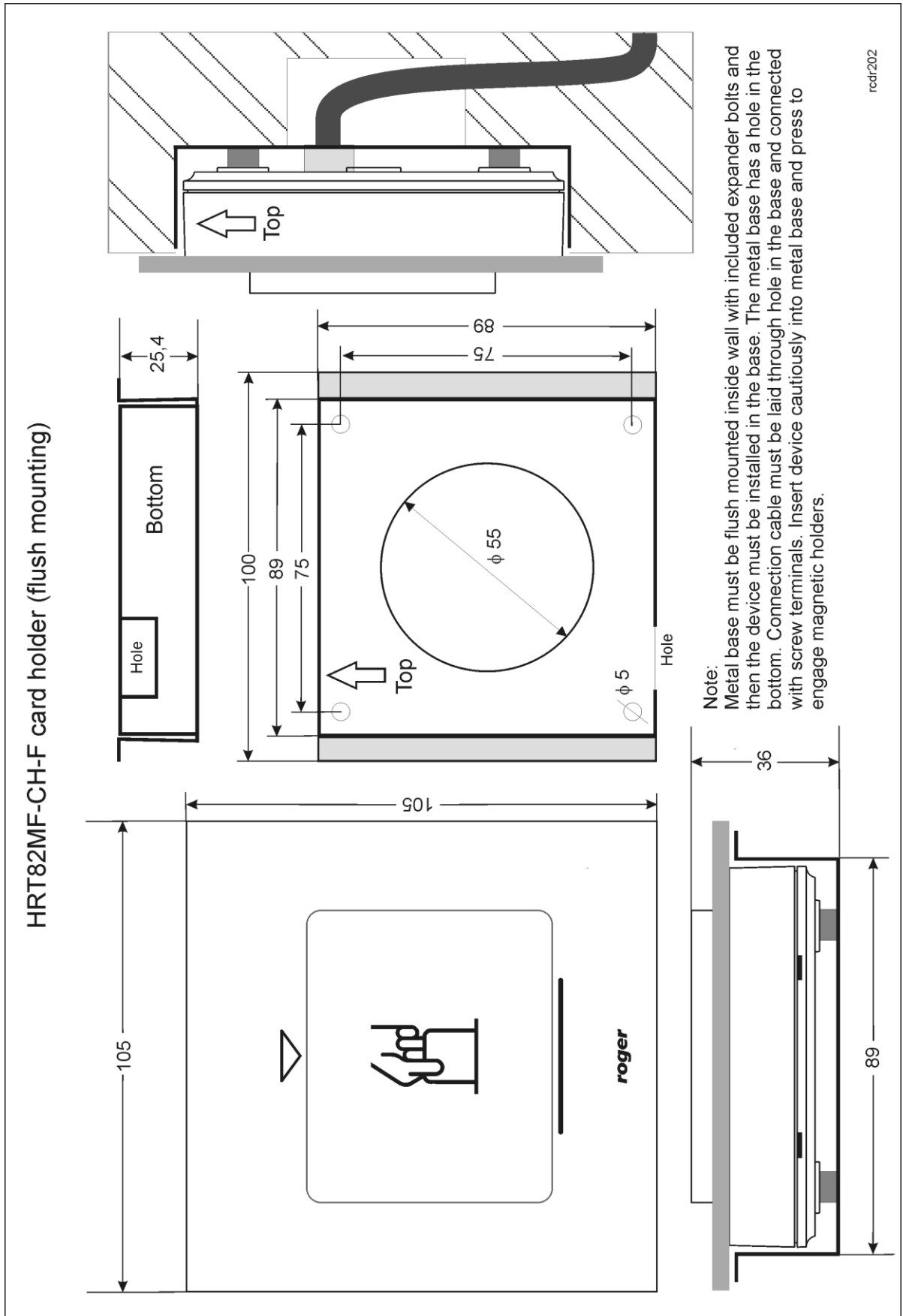

Fig.5 HRT82MF-CH-F flush mounting

## 4. CONFIGURATION

### 4.1 Device programming

The address of factory new HRT82MF-CH is ID=0 and such device is ready to communicate with HRC series controller requiring no additional configuration.

If necessary, HRT82MF-CH settings can be modified with RogerVDM software (available at [www.roger.pl](http://www.roger.pl)) after connection to RUD-1 communication interface.

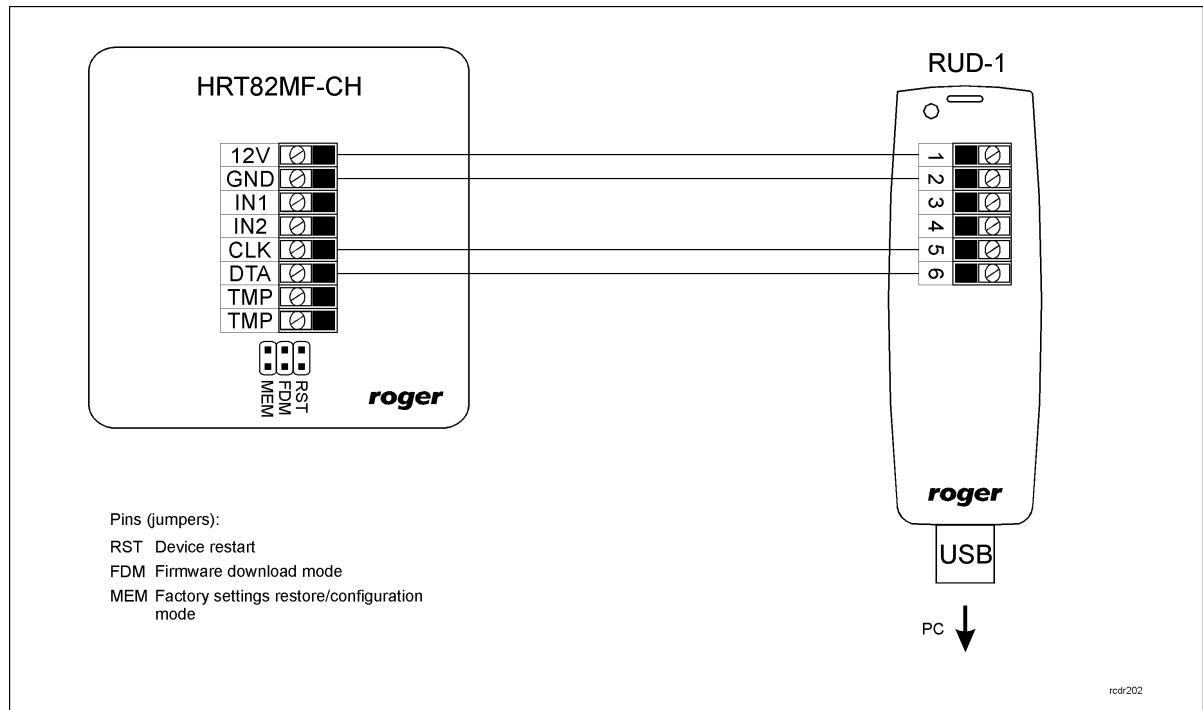

Fig. 6 HRT82MF-CH and RUD-1 connection

#### Connection and configuration procedure

1. Connect device to RUD-1 communication interface according to fig. 6
2. Place jumper on MEM pins
3. Restart the device (place and remove jumper on RST pins or switch power supply off and on)
4. Install and start RogerVDM software
5. In the opened window select device, firmware version, communication channel and serial port with connected RUD-1 – see fig. 7
6. Select *Connect* button, the software shall establish connection with the device and automatically switch to configuration window
7. Enter required settings (configuration window is shown in fig. 8, while options are described in table 3)
8. Select *Send to Device* button – the software shall upload new settings
9. Remove jumper from MEM pins
10. Restart the device (place and remove jumper on RST pins or switch power supply off and on)

#### Note:

During connection procedure placing jumper on MEM pins and restarting the device restores its factory default settings.

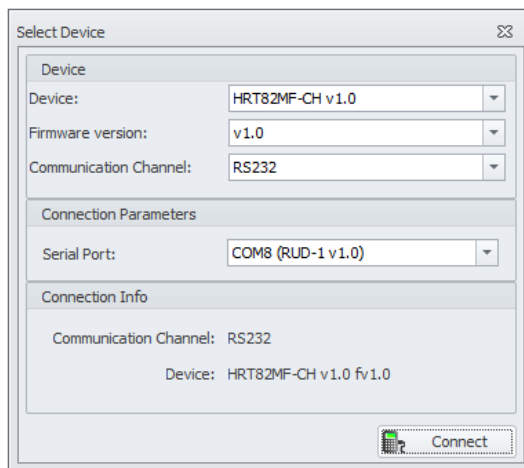

Fig. 7 Device select window in RogerVDM software

General	Device name	none
Transmission Format	RACS CLK/DTA Address	0
	Communication Timeout	20.0
Acoustic Signalization	Buzzer loudness level	[5]: 100%
CSN Number Settings	CSN Number of Bytes	8
Mifare Classic Settings	Card Number	[0]: CSN
	Format	[0]: BIN
	LSB	0
	MSB	7
	Sector ID	0
	AID	5156
	Block ID	0
	Key Type	[0]: A
	Key	FFFFFFFFFFFF

Fig. 8 Configuration window in RogerVDM software

Table 3. Configuration parameters		
Parameter	Values	Description
General		
Device Name	16 ASCII characters	Device description which can be filled with any comment by installer
Transmission Format		
RACS CLK/DTA Address	0..15	Device address on RACS CLK/DTA bus. Default address ID=0 is required for communication with HRC controller.
Communication timeout	0..255	The device signals communication failure when selected timeout [0.5s] elapses. When 0 is selected then failure is not signalled at all.
Acoustic Signalization		
Buzzer loudness level	0..100%	Buzzer loudness level. Buzzer is switched off when 0 level is selected
CSN Number Settings		



CSN Number of Bytes	0..8	The parameter specifies how many bytes of read only Chip Serial Number (CSN) is used in UID card number.
<b>Mifare Classic Settings</b>		
Card number	CSN, MSN, SSN	When CNS is selected then UID includes only this number. When MSN or SSN is selected then it is possible to use administrator defined UID. It is also possible to define UID consisting partially of CSN and MSN or SSN.
Format	BIN, HEX ASCII	Card number format. When BIN is selected then bytes from card correspond to UID number. When HEX ASCII is selected then bytes from card correspond to UID in ASCII hexadecimal format.
LSB	0..15	The location of MSN or SSN first byte.
MSB	0..15	The location of MSN or SSN last byte.
Sector ID	0..39	Sector number with SSN. For MSN this setting is disabled.
AID	0000..FFFF	AID number in MAD sector which defines sector with MSN. For SSN this setting is disabled.
Block ID	0..14	Block number in the sector with MSN or SSN.
Key Type	A, B , Roger	Type of key used for reading MSN or SSN.
Key	000000000000..FFFFFFFF	Six bytes key used for reading MSN or SSN.

## 4.2 Firmware update

HRT82MF-CH firmware can be updated with RogerVDM (available at [www.roger.pl](http://www.roger.pl)) after connection to RUD-1 communication interface.

### Firmware update procedure

1. Connect device to RUD-1 communication interface according to fig. 6
2. Install and start RogerVDM software
3. Close *Select Device* window
4. In top menu select *Tools->Update firmware*
5. In the opened window select device, port with connected RUD-1 and specify path to firmware file (\*.hex) – see fig. 9
6. According to displayed message place jumper on FDM pins and restart the device (place and remove jumper on RST pins or switch power supply off and on)
7. Select *Update* button
8. After firmware upload remove jumper from FDM pins and reset device (place and remove jumper on RST pins or switch power supply off and on)

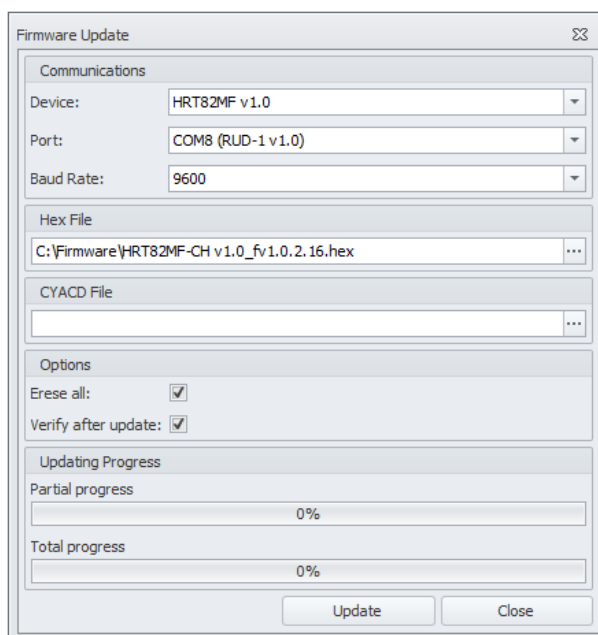

Fig. 9 Firmware update window in RogerVDM software

### 4.3 Memory reset

In order to restore HRT82MF-CH factory default settings place jumper on MEM pins and then restart the device either by placing and removing jumper on RST pins or by switching power supply off and on. Moreover, memory reset is also part of connection and configuration procedure (see 4.1).

## 5. TROUBLESHOOTING

<b>Table 4. Troubleshooting</b>			
Issue	Visual indication	Acoustic indication	Solution
No communication with controller	Green-red backlight is blinking.	-	<ol style="list-style-type: none"> <li>1. Check if RACS CLK/DTA bus is properly connected, wires are undamaged and the bus does not exceed 150 m. All devices connected to particular RACS CLK/DTA bus should have common supply minus (GND).</li> <li>2. Check if the controller is properly configured for communication with the device.</li> </ol>
Device configuration error	Green backlight single blinking every 2 sec.	Short beep every 2 sec.	1. Connect the device to PC with RogerVDM software and configure it again (see 4.1).
Device firmware error	Green backlight double blinking every 2 sec.	Short double beep every 2 sec.	1. Upload the firmware again (see 4.2)

## 6. ORDERING INFORMATION

<b>Table 5. Ordering information</b>	
HRT82MF-CH	MIFARE hotel card holder
RUD-1	Communication interface with 12VDC power supply output

## 7. PRODUCT HISTORY

<b>Table 6. Product history</b>		
Version	Released	Description
HRT82MF-CH v.1.0	07/2014	The first commercial version of the product

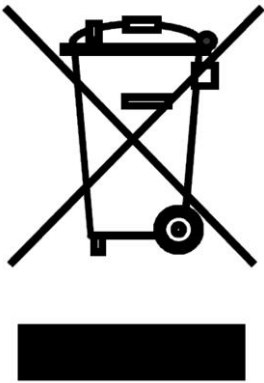
	<p>This symbol placed on a product or packaging indicates that the product should not be disposed of with other wastes as this may have a negative impact on the environment and health. The user is obliged to deliver equipment to the designated collection points of electric and electronic waste. For detailed information on recycling, contact your local authorities, waste disposal company or point of purchase. Separate collection and recycling of this type of waste contributes to the protection of the natural resources and is safe to health and the environment. Weight of the equipment is specified in the document.</p>
---	---

**Contact:**  
**Roger sp. z o.o. sp.k.**  
**82-400 Sztum**  
**Gościszewo 59**  
**Tel.: +48 55 272 0132**  
**Fax: +48 55 272 0133**  
**Tech. support: +48 55 267 0126**  
**E-mail: [support@roger.pl](mailto:support@roger.pl)**  
**Web: [www.roger.pl](http://www.roger.pl)**