

Roger Access Control System

Installation guide for PR102DR/PR102DR-BRD Access Controllers

Firmware version: 1.18.6 or newer

Hardware version: 1.0 or newer

Document version: Rev. I

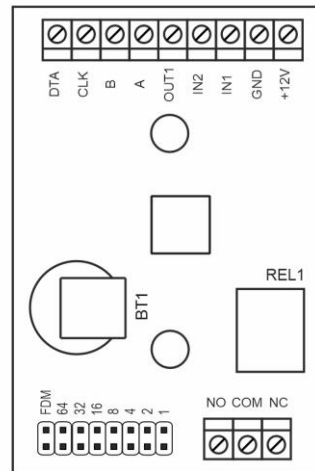
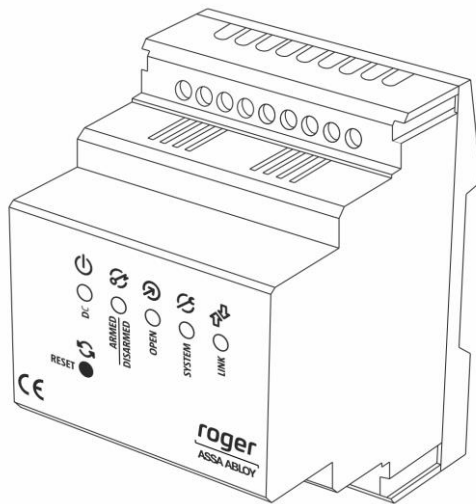

Contents

1. Introduction	Błąd! Nie zdefiniowano zakładki.
1.1 This manual	Błąd! Nie zdefiniowano zakładki.
2. Description and Specification	3
3. Installation	4
3.1 Terminals and connection diagram	4
3.2 Front panel	6
3.2.1 PR102DR controller	6
3.2.2 PR102DR-BRD controller	6
3.3 Power supply	7
3.4 Connection of door lock	7
3.5 Communication with controller	7
3.6 Communication of controller with peripheral devices	8
3.7 Input and output lines	8
3.7.1 Inputs.....	8
3.7.2 Relay output	8
3.7.3 General purpose output	8
3.8 Installation guidelines	8
4. Configuration	9
4.1 Controller address	9
4.1.1 Addressing by means of jumpers	9
4.1.2 Addressing during firmware update (Fixed ID)	10
4.1.3 Addressing during Memory Reset procedure.....	10
4.1.4 Addressing by means of PR Master software	10
4.2 Memory Reset procedure	10
4.2.1 Simplified Memory Reset Procedure (firmware 1.18.6 or newer)	11
4.2.2 Simplified Memory Reset Procedure (firmware older than 1.18.6)	11
4.2.3 Full Memory Reset procedure	11
4.3 Controller programming	11
4.4 Firmware update	12
5. Ordering information	12
6. Product history	13

This document is subject to the Terms of Use in the current version published on the website www.roger.pl. The manufacturer reserves the right to make changes to the product without prior notice. © ROGER sp. z o. o. sp.k. All rights reserved.

1. INTRODUCTION

1.1 This manual

This manual contains minimum information that is necessary to properly install devices and to perform initial tests. Following documents which are available at www.roger.pl supplement this manual:

- Functional description of PRxx2 series controllers
- PR Master User Manual

If PR102DR and P102DR-BRD controllers are not clearly distinguished in particular paragraph, then information specified for PR102DR is also valid for PR102DR-BRD. But if PR102DR-BRD name is used in particular paragraph then the information concerns only that specific type of controller.

2. DESCRIPTION AND SPECIFICATION

PR102DR is single door access controller used in RACS 4 access control system. Both PR102DR and PR102DR-BRD versions are functionally identical but differ mechanically. PR102DR is installed inside plastic enclosure fitted to mounting on DIN 35 mm rail, while PR102DR-BRD is just a PCB module without enclosure.

The new, factory-made controller has the address ID=00 and MASTER proximity card is included. The card can be used for the initial tests after connection of external reader. PR102DR controllers are not equipped with built-in reader and they require connection of external reader(s) operating in RACS CLK/DTA (PRT series terminals).

Controllers can be configured with PR Master software installed on computer and they can be connected to computer by means of communication interface e.g. UT-2USB, UT-4DR, RUD-1 or by means of CPR32-NET network controller.

Note: Full functionality of PR102DR is available in PR Master 4.5.6 or newer.

Table 1. Specification	
Nominal supply voltage	12VDC
Nominal supply current	40mA
Inputs	Two (IN1,IN2) NO/NC inputs, electrically biased to +12V via 15kΩ resistor, triggering level app. 3.5V
Relay output	One (REL1) relay output with single NO/NC contact, 30V/1.5A
Transistor output	One (OUT1) open collector output, 15VDC/150mA
Distances	Between controller and communication interface (RS485): max. 1200m Between controller and PRT reader (RACS CLK/DTA): max. 150 m Between controller and XM expander (RACS CLK/DTA): max. 150 m
Operational environment	Indoor general conditions, temperature: +5°C to +40°C, relative humidity: 10 to 75% (no condensation)
Dimensions HxWxD	PR102DR: 85 x 62 x 73mm PR102DR-BRD: 80 x 54 mm
Weight	PR102DR: approx. 115g PR102DR-BRD: approx. 50g
Compliance	CE, RoHS

3. INSTALLATION

3.1 Terminals and connection diagram

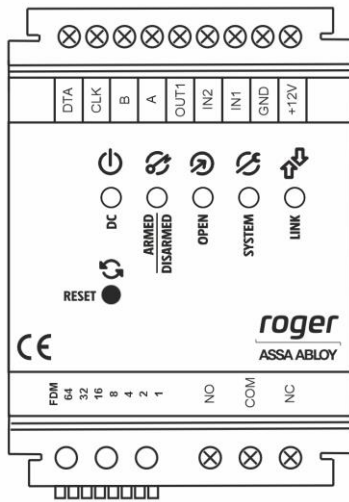

rcdr166

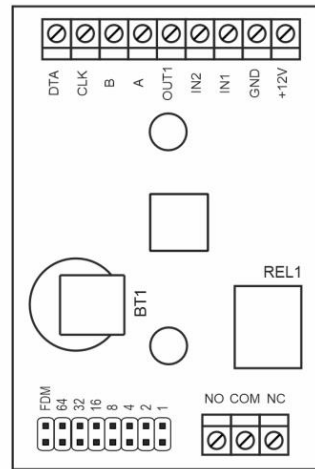

rcdr166

Fig. 1 PR102DR and PR102DR-BRD controllers

Table 2. PR102DR terminals			
Terminal	Description	Terminal	Description
DTA	RACS CLK/DTA comm. bus	IN1	IN1 input line
CLK	RACS CLK/DTA comm. bus	GND	Ground
B	RS485 communication bus	+12V	12VDC power supply
A	RS485 communication bus	NO	REL1 relay output (NO)
OUT1	OUT1 output line	COM	REL1 relay common terminal
IN2	IN2 input line	NC	REL1 relay output (NC)

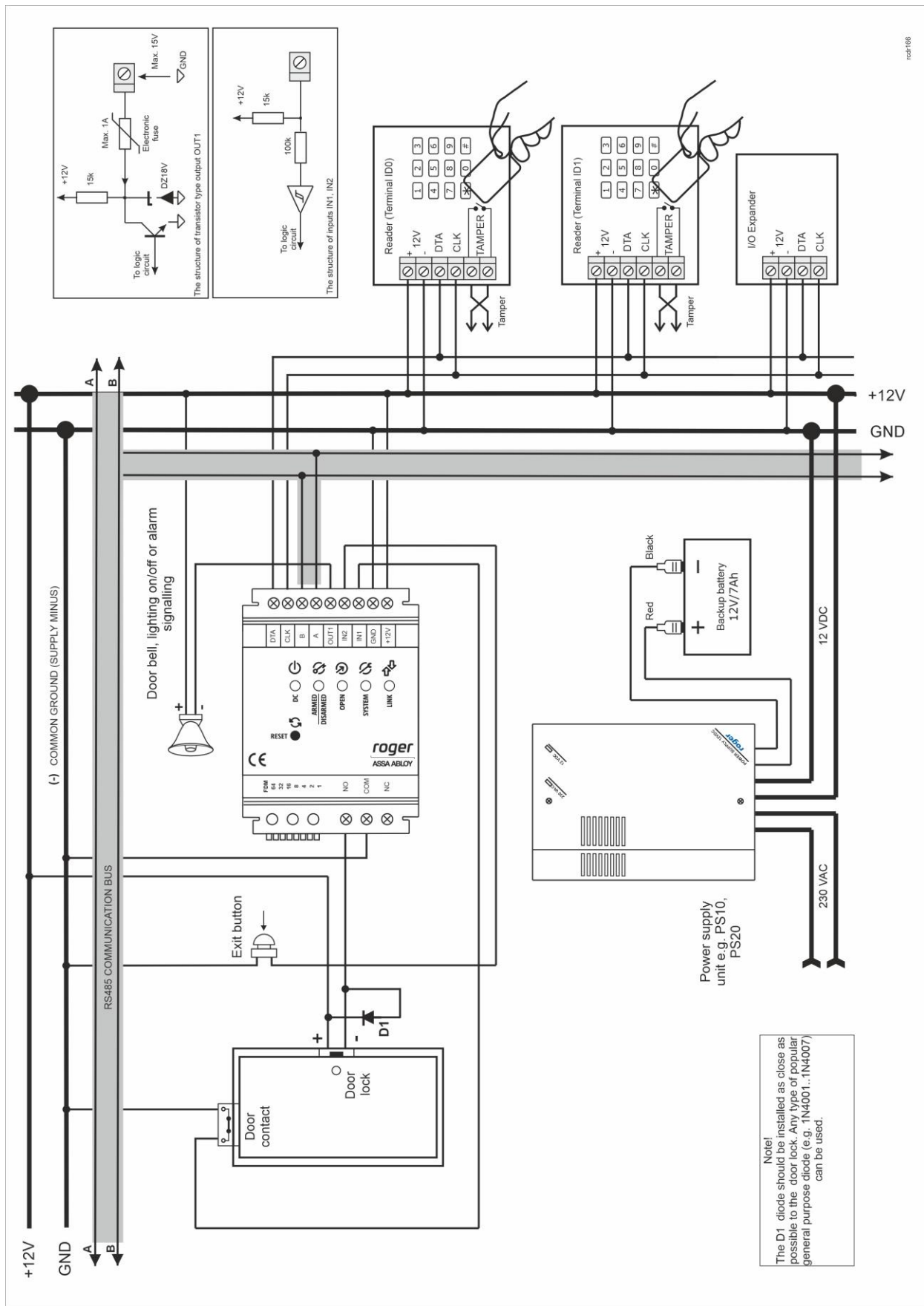

Fig. 2 PR102DR connection diagram

3.2 Front panel

3.2.1 PR102DR controller

According to fig. 3, the PR102DR controller is equipped with LED indicators on front panel to indicate various states of the device and with RESET button to restart the controller in the same way as in case of powering device off and then on. The RESET button can also be used during Memory Reset procedure and during firmware update procedure.

DC	DC supply
ARMED/DISARMED	Current arming mode
OPEN	Door unlocked
SYSTEM	Various signalling functions
LINK	Data transmission on RS485 bus

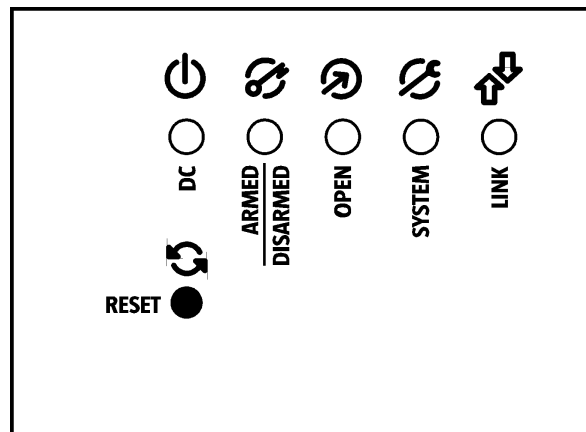

rcdr166

Fig. 3 PR102DR front panel

3.2.2 PR102DR-BRD controller

According to fig. 4, PR102DR-BRD is equipped with 4 LED indicators and RST button on its PCB. The button can be used to restart the controller in the same way as in case of powering device off and then on. The button can also be used in Memory Reset procedure and in firmware update procedure.

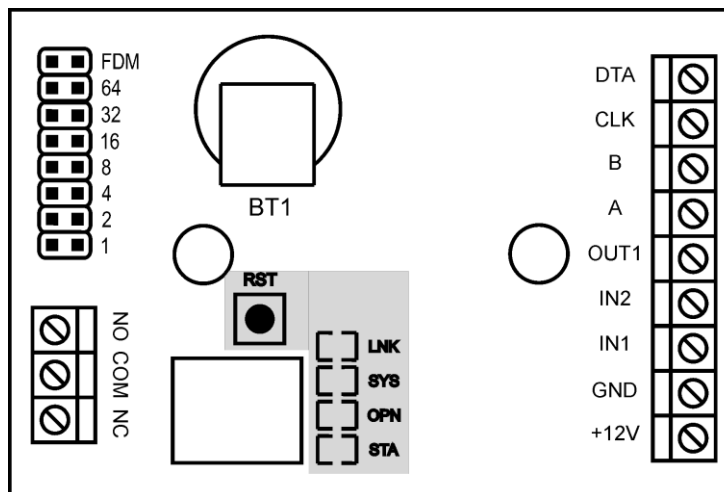

rcdr166

Fig. 4 LED indicators of PR102DR-BRD controller

Table 5. LED indicators of PR102DR-BRD controller	
STA	Armed/Disarmed mode
OPN	Door unlocked
SYS	Various signalling functions
LNK	Data transmission by means of RS485 bus

3.3 Power supply

Controllers require 12VDC nominal power supply. The power should be connected to the 12V line and GND line. Additionally, the GND line can be used as reference potential for the RS485 bus, IN1-IN3 input lines and RACS CLK/DTA bus.

The power supply can be provided by means of power supply unit (e.g. PS-15DR, PS20) which can be equipped with backup battery in order to ensure operation of access control in case of power failure.

Note: All devices connected to RS485 bus (including controllers) should have the same supply minus (GND). In order to ensure this, all the GND terminals from various power supply units within the system should be connected with each other using separate wire. Alternatively, the common supply minus of the entire system can be earthed however only in one point.

3.4 Connection of door lock

In majority of cases, door locking devices are inductive type. It means that overvoltage (voltage surge) can occur when current flow is interrupted and it can interfere with the controller electronic components. In extreme cases it may result in improper operation of the controller or even freeze. Moreover, overvoltage condition causes quicker wear of relay contacts. In order to limit this adverse effect, it is necessary to use a general type semiconductor diode e.g. 1N4007 (one piece of such diode is included with the controller). The diode should be connected as close as possible to the inductive element (electric strike or magnetic lock).

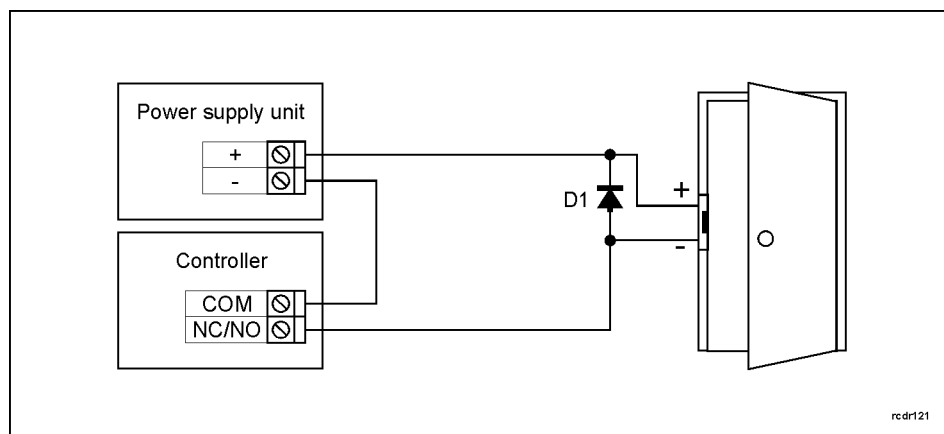

Fig. 5 Connection of door lock

3.5 Communication with controller

RS485 bus and UT communication interface (e.g. UT-2USB) are used for communication with controller. Single RS485 bus creates network (subsystem) and up to 32 controllers with unique addresses in range of 00.99 can be connected to the bus. For the communication with distant subsystems it is required to use UT-4DR or UT-4 v2.0 communication interface or CPR32-NET network controller as all of them enable communication through computer network (LAN or WAN). The RS485 bus consists of two signal lines A and B. In the RACS 4 system any topology can be used (star, tree or any combination of them, except for loop) in order to connect controllers in network (subsystem). The matching resistors (terminators) connected at the ends of transmitting

lines are not required. In most cases communication works with any cable type (standard telephone cable, shielded or unshielded twisted pair etc.) but the recommended cable is unshielded twisted pair (U/UTP cat.5). Shielded cables should be limited to installations subject to strong electromagnetic interferences. The RS485 communication standard used in the RACS 4 system guarantees proper communication in a distance of up to 1200 meters as well as high resistance to interferences.

3.6 Communication of controller with peripheral devices

The communication of controller and peripheral devices can be established by means of RACS CLK/DTA bus. RACS CLK/DTA is the addressable bidirectional communication standard developed by Roger company. Addresses of all devices connected to CLK and DTA lines must be properly configured in range of 0..15. Factory default address of peripheral devices can be changed according to procedures specified in their manuals but in majority of cases it is not necessary to modify the addresses at all. Standard unshielded signal cables (e.g. U/UTP cat. 5) with maximal length of 150m can be used for RACS CLK/DTA communication. Practically, devices communicating on RACS CLK/DTA bus can be connected to the controller in distance up to 500m, but such conditions are not guaranteed by the manufacturer.

PR102DR controller can operate with two PRT series readers, XM-2 I/O expander, up to four XM-8 expanders dedicated to access control in elevators and HRT82FK function key panel. Addresses of PRT readers must be ID=0 and ID=1, the address of XM-2 expander must be ID=5, addresses of XM-8 expanders must be in range of ID=8..11 and the address of HRT82FK must be ID=12. All mentioned devices must be connected to CLK and DTA lines of the controller.

3.7 Input and output lines

Functions are assigned to inputs and outputs by means of PR Master software. Default function for REL1 relay output is door unlocking.

3.7.1 Inputs

All inputs (IN1, IN2) of controllers have identical electric structure and can be configured as NO or NC lines using PR Master software. The NO input is triggered by shorting it to supply minus (GND) while the NC input must be normally shorted to supply minus (GND) and it becomes triggered when connection with GND is interrupted. Every input is internally connected (pulled up) to the power supply plus (+12V) through a 15kΩ resistor.

3.7.2 Relay output

Controllers offer one relay output (REL1) with single switching contact. Maximum load for REL1 equals to 30V/1.5A. In the normal state (relay is off) the NC-COM contacts are shorted. In the triggering state (relay is on) the NO-COM contacts are shorted. In case of power outage both relays remain in the off state.

3.7.3 General purpose output

Controllers offer single transistor output (OUT1). The output is open collector type i.e. in normal (off) state is pulled to supply plus via 15kΩ resistor and when in trigger (on) state it shorts to supply minus. Maximum load for the output equals to 15VDC/1A. In case of overcurrent outputs are automatically switched off and controller automatically restarts.

3.8 Installation guidelines

- Install devices in such way as to ensure easy access to screw terminals, addressing jumpers, RST button and FDM jumper of the controller.
- Prior to controller installation it is recommended to configure its address (ID number) – see 4.1 Controller address
- The controller is delivered with MASTER proximity card, however any proximity card in EM 125kHz (UNIQUE) standard can be programmed as MASTER card.
- All electric connections must be made with power supply switched off.
- All devices connected to the same communication bus (RS485 and RACS CLK/DTA) should be connected to the same negative potential (GND). Therefore all GND terminals from various power supply units used in the system should be connected with each other.

- General purpose diode e.g. 1N4007 should be always connected in parallel and as close as possible to the door locking device (magnetic lock, electric strike, relay, contactor).
- It is required to install readers in minimal distance of 0.5m from each other. If two readers have to be installed on opposite sides of the same wall, it is recommended not to place them directly opposite (in the same axis). If this condition cannot be fulfilled then place metal plate between reader and wall as well as non-metal spacer with 10mm minimal thickness between reader and metal plate.
- Because of relatively low magnetic field readers should not interfere with other devices, however its operation can be disrupted by devices generating strong electromagnetic field.
- If the range of card reading is significantly lower than specified in technical documentation then consider relocation of the reader.
- Readers can be installed on metal surfaces but in such case reduction of reading distance should be expected. The reading distance reduction effect can be minimized by installing readers on non-metal spacer with minimal thickness of 10 mm (e.g. PVC).
- The electronic device/module contains electronic components sensitive to ESD. Activities involving contact with the electronic module may only be performed by a person free from the electrostatic charge.
- The installation may only be performed by a qualified person with appropriate permits and authorizations for connecting and intervening in 230VAC and low-voltage networks.

4. CONFIGURATION

4.1 Controller address

If controller works autonomously (standalone mode), then address setting can be skipped and default address ID =00 can be used but if the controller is to be connected with other controllers by means of RS485 bus and operate in network system, then it is necessary to assign unique address to such controller (ID number from range 00..99). Two or more devices with the same address result in communication conflict and make a proper communication with these devices impossible. Following addressing methods are available:

- By means of jumpers
- During update of controller firmware by means of Roger ISP software (so called Fixed ID)
- Manually during Memory Reset procedure
- By means of PR Master software

The first two methods enable configuration of hardware addresses while the remaining two enable configuration of software addresses. The main difference between these two addressing methods is such that software address contrary to hardware address can be modified using any of mentioned methods. Jumper address has the highest priority, Fixed ID has lower priority and software addresses have the lowest priority.

Note: A new controller can be connected to the existing system without the necessity to change its address but only if no other controller operates with default address ID=00. Once the controller is connected to the RS485 communication bus, it should be detected by means of PR Master software and new address should be configured.

4.1.1 Addressing by means of jumpers

The address of controller can be set by means of jumpers – see fig. 6. Each time the new address is configured, controller must be restarted (via RESET button or powering device off and on) to make new settings valid. The address range is 00..127 and if the address is in range 100..127 then the controller ignores such setting and all other addressing methods can be used. If the address is in range of 00..99 then it has the highest priority, FixedID is not effective, and the address cannot be changed by PR Master software nor manually during Memory Reset procedure.

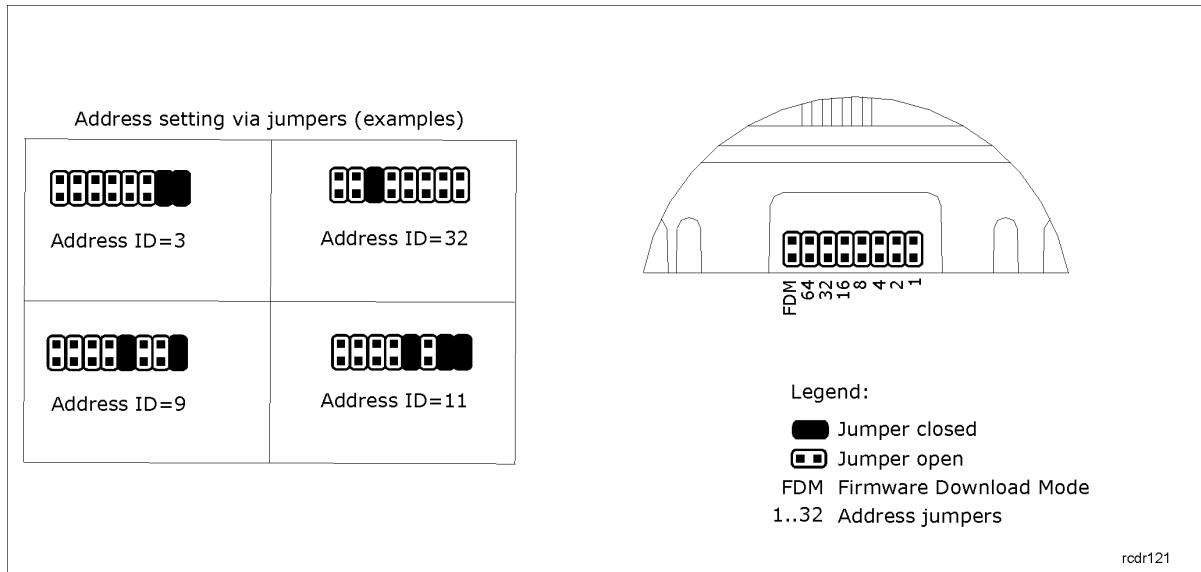

Fig. 6 Addressing jumpers

4.1.2 Addressing during firmware update (Fixed ID)

FixedID can be set during update of the controller firmware by means of RogerISP software. Prior to firmware upload, RogerISP software offers the possibility to set Fixed ID address in range of 00..99 or disable it (FixedID=None). Once the FixedID is selected and uploaded to the controller software addressing is ignored. In order to disable or modify FixedID it is necessary to start firmware upload procedure or configure jumper address in range of 00..99.

Note: When FixedID is configured then controller address cannot be modified based on software addressing method. FixedID address is maintained even in case of controller configuration error. Therefore controller can be always detected on the communication bus with the same address by means of PR Master software.

4.1.3 Addressing during Memory Reset procedure

Software address can be configured during Memory Reset procedure – see 4.2 Memory Reset procedure.

Note: Software address is effective only if the address set with jumpers on the controller is in range of 100-127 and FixedID is None.

4.1.4 Addressing by means of PR Master software

Software address can be configured by means of PR Master software. In such case connect the controller to PC via communication interface (e.g. UT-2USB, UT-4DR) or via CPR32-NET network controller, detect the controller and configure the address.

Note: Software address is effective only if the address set with jumpers on the controller is in range of 100-127 and FixedID is None.

4.2 Memory Reset procedure

Memory Reset procedure enables erasing of current settings and returning to default factory settings. Full procedure also allows to program new Master card/PIN as well as new address of the controller. After Memory Reset procedure, the controller automatically enters normal working mode.

Note: If current address of the controller is hardware type (see 4.1 Controller address) i.e. FixedID or configured by means of jumpers in range of 00..99 then address selected during Memory Reset procedure is ignored.

4.2.1 Simplified Memory Reset Procedure (firmware 1.18.6 or newer)

Simplified Memory Reset restores default settings with controller address ID=00.

- Remove connections to CLK and IN1 terminals
- Connect CLK with IN1
- Restart the controller (press RESET button or switch power supply off/on) - LED OPEN  shall start to pulsate
- Disconnect CLK and IN1
- After a few seconds the controller shall restart automatically and switch to normal mode

4.2.2 Simplified Memory Reset Procedure (firmware older than 1.18.6)



Simplified Memory Reset restores default settings with controller address ID=00 and enables programming of new MASTER card. This procedure requires connection of any PRT series reader.

- Remove connections to CLK and DTA terminals
- Connect CLK with DTA
- Restart the controller (press RESET button or switch power supply off/on) - LED OPEN  shall start to pulsate
- Disconnect CLK and DTA
- Connect PRT series reader to CLK and DTA lines (without switching power supply off) and take further steps by means of this reader.
- Read any card at the reader, this will be a new MASTER card
- After a few seconds the controller shall restart automatically and switch to normal mode

4.2.3 Full Memory Reset procedure

Full Memory Reset restores default settings and enables programming of new MASTER card, MASTER PIN and controller ID address. This procedure requires connection of PRT series reader with keypad (e.g. PRT12LT).

- Remove connections to CLK and DTA terminals
- Connect CLK with DTA
- Restart the controller (press RESET button or switch power supply off/on) - LED OPEN  shall start to pulsate
- Disconnect CLK and DTA
- Connect PRT series reader with keypad (e.g. PRT12LT) to CLK and DTA lines (without switching power supply off) and take further steps by means of this reader
- Enter new MASTER PIN (3 to 6 digits) followed with the [#] key or skip this step and press only the [#] key
- Read any card at the reader, this will be a new MASTER card or skip this step and press only the [#] key
- Enter two digits (in range of 00 to 99) by means of keypad, this will be new ID address or skip this step and press only the [#] key so the default ID=00 could be assigned
- After a few seconds the controller shall restart automatically and switch to normal mode

After Memory Reset controller resumes its work with default factory settings and configured address. You can then test its operation using MASTER card or PIN (if available). Using the MASTER card/PIN once activates the REL1 output for 4 seconds (LED OPEN ). Using the MASTER card/PIN twice switches the IO1 output to the opposite state and switches Arm/Disarm Mode (LED STATUS  changes its colour).

4.3 Controller programming

Controllers can be configured by means of:

- PR Master software installed on computer connected to the controller via communication interface (e.g. UT-2USB, UT-4DR) or via CPR32-NET network controller.
- Commands entered with keypad of PRT series reader connected to the controller (limited settings only)

More information on controller programming can be found in the document Functional description of PRxx2 series controllers as well as in PR Master User Manual, which are available at www.roger.pl.

4.4 Firmware update

The latest versions of firmware and Roger ISP software are available at www.roger.pl. In order to update firmware it is necessary to connect the device by means of RS485 bus to communication interface (UT-2USB or RUD-1) and then connect the interface to PC with installed Roger ISP software. It is not necessary to disconnect the controller from access control system, it is only required to place FDM jumper in order to put the device in firmware download mode. Therefore firmware update can be performed by means of RS485 bus of access control system.

Firmware update procedure

- Place jumper on FDM pins (see fig. 6)
- Reset device (press RESET button or switch power off/on)
- Start RogerISP software and select communication port (in case of RUD-1 select **USB-RS485 Converter**).
- Press the button **Erase**
- Once more reset device (place and remove jumper on RST pins or switch power off/on)
- In Firmware window select firmware *.hex file (can be downloaded from www.roger.pl) and then select the button **Program**
- After firmware upload remove jumper from FDM pins and reset device (press RESET button or switch power off/on)

Note: If the controller is not responding and LED SYSTEM  (orange) is on after firmware update then it is necessary to reset – see 4.2 Memory Reset procedure or update firmware once more.

Note: In case of network system, it is required to restart controller within PR Master software by right clicking particular controller and selecting the option **Restart controller and verify version**.

5. ORDERING INFORMATION

Table 6. Ordering information	
PR102DR	Access controller in enclosure adapted for installation on DIN 35mm rail.
PR102DR-BRD	Electronic module of PR102DR controller.
ME-2-D	Metal enclosure with 13.8VDC/3.5A power supply unit, adapted for 8 x PR102DR controllers.
ME-5-S	Metal enclosure with 13.8VDC/11A power supply unit, adapted for 18 x PR102DR controllers.
ME-43-S	Metal enclosure with 13.8VDC/4A power supply unit, adapted for 8 x PR102DR controllers.
ME-44-S	Metal enclosure with 13.8VDC/10A power supply unit, adapted for 18 x PR102DR controllers.
PS-15DR	13.8VDC/1.5A power supply unit adapted for installation on DIN 35mm rail.
CPR32-NET-BRD	Electronic module of network controller.
UT-4DR	Ethernet-RS485 communication interface.
UT-2USB	USB-RS485 communication interface.
RUD-1	Portable USB-RS485 communication interface with 12VDC/0.12A output.

6. PRODUCT HISTORY

Product version	Released	Description
PR102DR v1.0	08/2012	The first commercial version of the product
PR102DR v2.0	03/2025	The second commercial version of the products

 	<p>This symbol placed on a product or packaging indicates that the product should not be disposed of with other wastes as this may have a negative impact on the environment and health. The user is obliged to deliver equipment to the designated collection points of electric and electronic waste. For detailed information on recycling, contact your local authorities, waste disposal company or point of purchase. Separate collection and recycling of this type of waste contributes to the protection of the natural resources and is safe to health and the environment. Weight of the equipment is specified in the document</p>
--	--

Contact:

Roger sp. z o.o. sp.k.

82-400 Sztum

Gościszewo 59

Tel.: +48 55 272 0132

Fax: +48 55 272 0133

Tech. support: +48 55 267 0126

E-mail: support@roger.pl

Web: www.roger.pl