

Roger Access Control System 5 v 2

Application note no. 027

Document version: Rev. A

Alarm zones and integration with alarm systems

Note: This document refers to RACS 5 v2.0.8 or higher

Introduction

RACS 5 system enables configuration of Alarm Zones which include Access Points (readers). These points are called Arming Points and they can be used to switch Armed mode and also grant access at Access Doors. Armed mode of the zone can be set with various means such as proximity card, PIN, input, schedule, remote command, etc. Based on configurable Authorisations it can be defined who and when can switch Armed mode of particular Alarm Zone. Additionally the system can deny access for users at Access Points as long as they are armed.

The functionality of Alarm zones can be used to provide additional access level and to offer the integration with intruder alarm systems. This note explains hardware integration which is based on inputs and output of both systems. Such approach to the integration is universal and can be practically applied to the vast majority of security alarm systems on the market.

The concept of integration is based on logical connection of RACS 5 Alarm zones which include Access Points (readers) with alarm system zones (detectors). In practical application it means that the Armed mode of reader(s) and associated detector(s) is the same. Therefore the integration:

- Makes the management of both systems more convenient as Alarm Zones in both systems can be controlled from devices of one of the systems e.g. RACS 5 readers.
- Allows to warn users about armed detectors in particular zone of alarm system as it can be presented on readers' LED indicators.
- Enables to avoid unnecessary alarms as the entry to the zone with armed detectors can be denied at access control readers because in such situation they would also be armed while getting into armed zone would require readers disarming which automatically results in detectors disarming.

Note: RACS 5 system offers also dedicated integration with Integra (SATEL) and Galaxy (Honeywell) intruder alarm panels which are explained in AN036 and AN013 application notes.

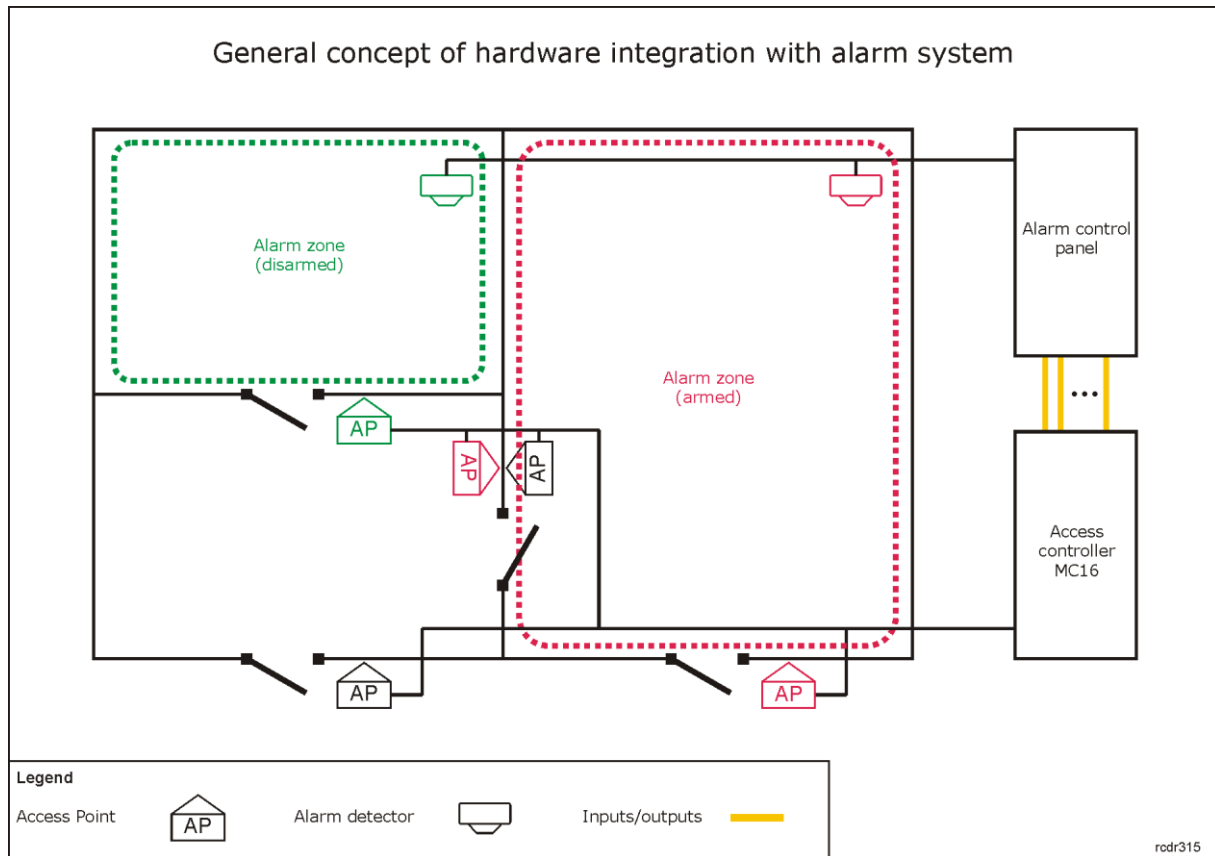

Configuration of Alarm Zones in RACS 5

RACS 5 system enables configuration of Alarm Zones, each within single RS485 bus including MC16 access controller and its peripheral devices such as readers and expanders. Alarm Zone includes Access Points (readers) called Arming Points which are armed/disarmed concurrently which means that all Arming Points of particular zone are always in the same Armed mode.

Configuration of Alarm Zone

- Configure access control system according to AN006 Application note.
- In the navigation tree of VISO software within particular MC16 access controller double click *Alarm Zones* command.
- In the opened window click *Add* button and optionally enter zone's name.
- Enable the option *Disable physical access when zone armed* if Access Points of armed zone are supposed to deny access to users with access rights till zone disarming. Click *OK* button.
- In the bottom select *Arming Points* tab and assign Access Points to the Alarm Zone. These points (readers) will be armed/disarmed concurrently within their zone.
- Upload settings to controller. Red LED SYSTEM indicator on a reader signifies armed zone while green LED SYSTEM indicator signifies disarmed zone.

Control of Alarm Zone

Alarm Zone in RACS 5 can be armed/disarmed by user with such Authentication Factors as card, PIN, fingerprint, etc. Additionally Alarm Zones can be armed/disarmed by input, function key, schedule, remote command and events registered in RACS 5 system.

Arming/disarming with proximity card

In case of proximity card it is necessary to decide what method of card reading(s) will arm/disarm a zone. It can be defined within Authentication Options on the level of Access Point. Armed mode

can be switched among others with single, double and long card readings. In order to define location and method for standard arming/disarming:

- In the navigation tree of VISO software within particular MC16 access controller double click *Access Points* command.
- In the opened window select Access Point to be used for arming/disarming and then in the bottom in the *Authentication Options* tab select *Edit* button.
- Assuming that arming/disarming will require two card readings, select *Double Authentication* tab, then the function *[102]: Set Alternately Armed ON/Armed OFF Mode* and select particular Alarm Zone as *Object*.

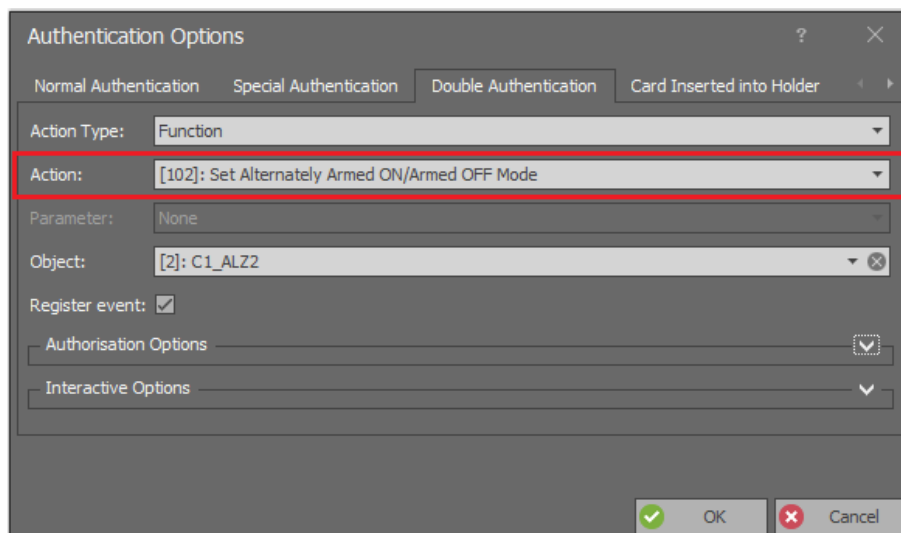

It is also possible to disarm automatically when access is granted. In such case the option *Quick Disarming* must be enabled within the properties of Alarm Zone and access authorisations as well as arming control authorisations must be assigned to user. However quick disarming can be used only in case further mentioned Method I.

If it is required to arm/disarm multiple Alarm Zones at once then further described hierarchy of Alarm zones or multifunction Local Command at Access Point level can be defined. It is also possible to define global arming/disarming i.e. on the level of the whole system instead of individual controllers.

Arming/disarming Authorisations

Authorisation for arming control can be assigned individually to users and it is defined separately to access authorisations. Arming/disarming Authorisations can be used to provide additional control of access as user can be denied access as long as Access Point is armed and the option *Disable physical access when zone armed* is enabled. In order to define Basic Authorisation for arming control:

- In the navigation tree of VISO software click and expand *Authorisations* command and then double click *Basic Authorisations* command.
- In the opened window create Authorisation with *Add* button.

Add Standard Authorisation

General

Enabled:

Name: AUTH_5

Type: Arming Control

Valid from: None 12:00 AM

Valid to: None 12:00 AM

Description:

Allowed Objects

Select All Unselect All

	Alarm Zone	Schedule
<input checked="" type="checkbox"/>	[2]: C1_ALZ2	Always
<input type="checkbox"/>	[3]: C1_ALZ3	Always
<input type="checkbox"/>	[4]: C1_ALZ4	Always

OK Cancel

- In the opened window select *Arming control* as *Type* and then in the bottom select which Alarm Zone(s) can be armed/disarmed by user with this Authorisation. These rights can be additionally limited in time by assignment of General Purpose Maintained Type schedules which must be earlier created with *Schedules* command in the navigation tree of VISO software.
- Upload settings to controller.
- Assign new Authorisation(s) to user(s) using *Add Person Online* and/or *Edit Person Online* wizards which are available when *Wizard* command is selected in the top menu of VISO software.

Basic Authorisation enable full control of selected Alarm Zones. If it is necessary to distinguish Authorisations for arming and disarming then it is necessary to define Advanced Authorisations. In order to configure Authorisation for arming only:

- In the navigation tree of VISO software click and expand *Authorisations* command and then double click *Advanced Authorisations* command.
- In the opened window create Authorisation with *Add* button.
- In the opened window select the function *[103]: Set Armed ON Mode* as *Action* and close with *OK* button.

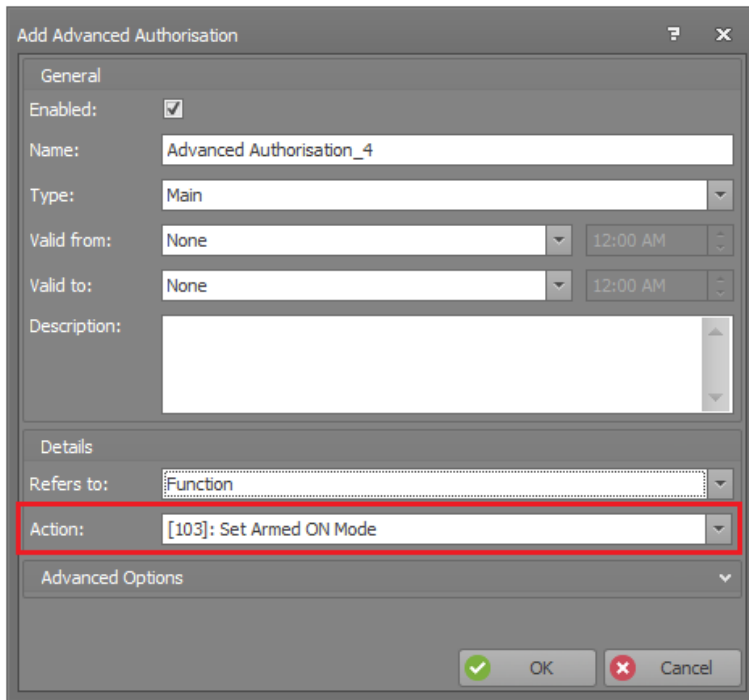

- In the bottom select *Positive Rules* tab and then *Add* button.
- In the opened window select *Specified as Time Range* and assign one of available schedule if the Authorisation is supposed to be limited by time. Own *General Purpose Maintained Type* schedule can be defined with *Schedule* command in VISO navigation tree.
- In the same window select *Specified as Range* and then assign particular Alarm Zone as *Value*. Multiple positive and negative rules can be defined within single Authorisation.
- Upload settings to controller.
- Assign new Authorisation(s) to user(s) using *Add Person Online* and/or *Edit Person Online* wizards which are available when *Wizard* command is selected in the top menu of VISO software.

Additional information on Authorisations is given in AN003 Application note which is available at www.roger.pl.

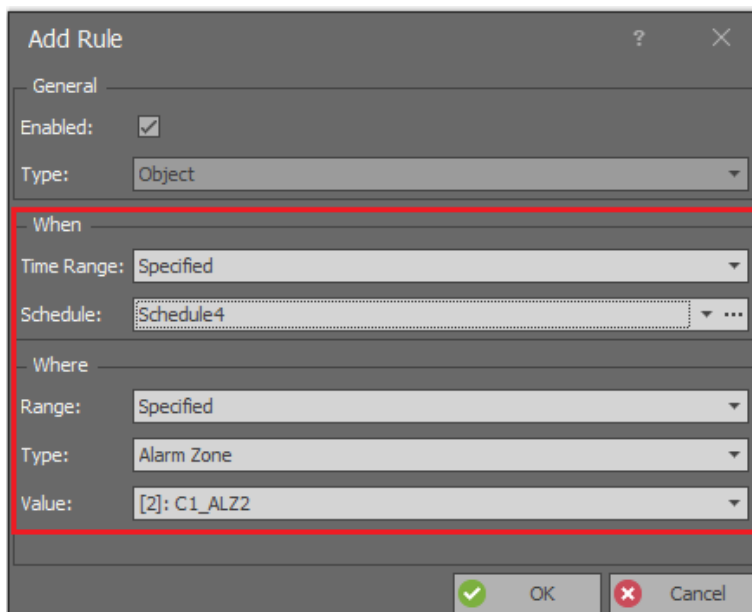

Arming/disarming with input

In case of arming control with input line not only function [102]: *Set Alternately Armed ON/OFF Mode* can be applied but also such functions as [101]: *Armed ON Mode Toggle*, [103]: *Set Armed ON Mode* and [104]: *Set Armed OFF Mode* as required. In order to define input with [102] function:

- In the navigation tree of VISO software within particular MC16 access controller double click *Alarm Zones* command.
- Select the zone, in the bottom select *Inputs* tab and then *Add* button.
- In the opened window select the button  to indicate the location of input.
- In the next window, in the *Name* field of *Object* area select particular input of controller or its peripheral device and click *OK*.
- In the opened window select the function [102]: *Set Alternately Armed ON/OFF Mode*.
- Upload settings to controller.

If input is configured as multifunction then multiple arming control functions for various Alarm Zones can be assigned to it. In such scenario single input can be used to control arming of multiple Alarm Zones. In order to configure input for arming control of two Access Zones:

- Create Alarm Zone and when location of input line for arming control is defined then expand *Additional Options* and enable the option *Multifunction* with limit 2. Close with *OK* button.

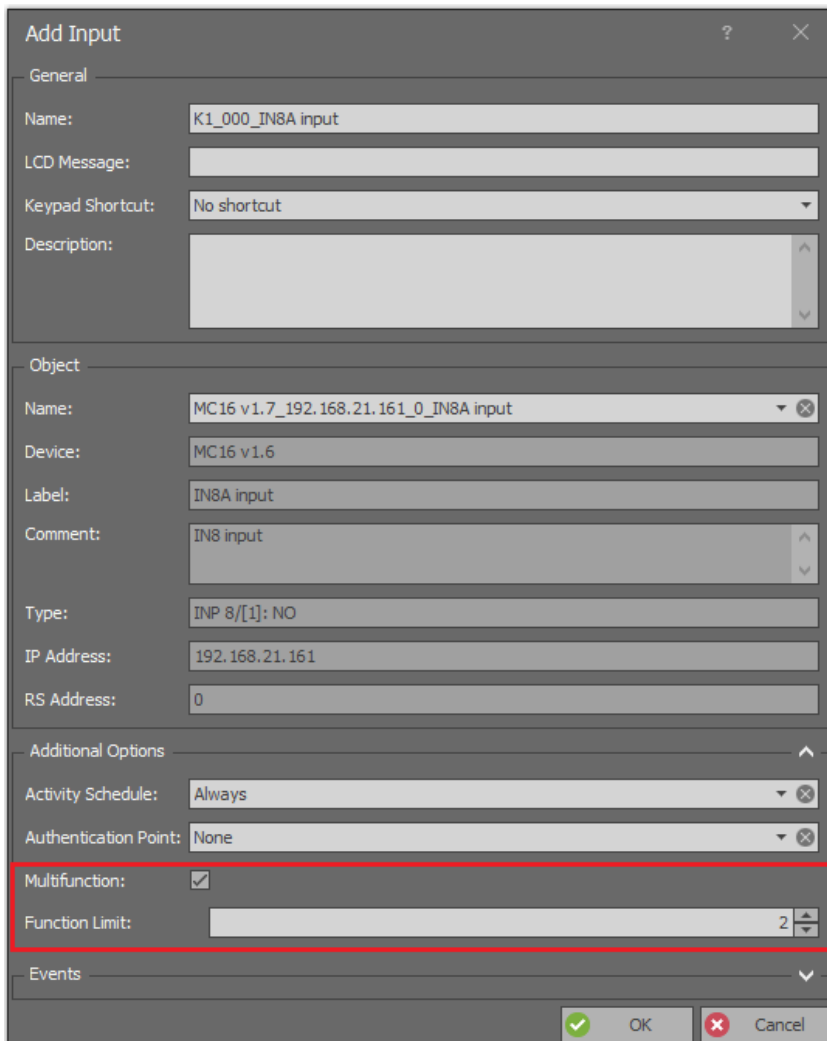

The screenshot shows the 'Add Input' dialog box with the following fields and values:

- General:** Name: K1_000_IN8A input; LCD Message: (empty); Keypad Shortcut: No shortcut; Description: (empty).
- Object:** Name: MC16 v1.7_192.168.21.161_0_IN8A input; Device: MC16 v1.6; Label: IN8A input; Comment: IN8 input; Type: INP 8/[1]: NO; IP Address: 192.168.21.161; RS Address: 0.
- Additional Options:** Activity Schedule: Always; Authentication Point: None; Multifunction: ; Function Limit: 2.
- Events:** (empty)

Buttons at the bottom: OK (green checkmark), Cancel (red X).

- In the opened window assign the function [102]: *Set Alternately Armed ON/OFF Mode*.
- Create another Alarm Zone.

- When input for its arming control is configured then there is no need to indicate the location of new input with the button  as IN8 input from the example above will be visible on the list for assignment despite of being already used in the previously created Alarm Zone.

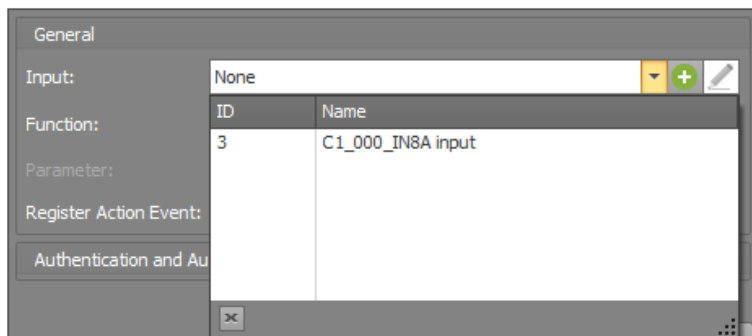

- Assign the function [102] and upload settings to controller.

If the Armed mode of Alarm Zone is controlled by input with the function [101]: *Armed ON Mode Toggle* then as long as the input is activated the Alarm Zone is armed and cannot be disarmed with any other method. When the input is deactivated then the zone becomes disarmed but then its arming with other methods is not blocked. This input can be used by external system (e.g. intruder alarm system) to control Alarm Zone in RACS 5.

Arming/disarming with function key

Function keys are available on keypad of selected readers (e.g. MCT12M). In order to configure function key for arming/disarming:

- In the navigation tree of VISO software within particular MC16 access controller double click *Alarm Zones* command.
- Select the zone, in the bottom select *Function keys* tab and then *Add* button.
- In the opened window select the button  to indicate the location of function key.
- In the next window, in the *Name* field of *Object* area select terminal with function key, then indicate particular key code e.g. F1 and close the window with *OK* button.
- In the opened window select the function [102]: *Set Alternately Armed ON/OFF Mode*.
- Upload settings to controller.

If function key is configured as multifunction then multiple arming control functions for various Alarm Zones can be assigned to it. In such scenario single function key can be used to arm/disarm multiple Alarm Zones.

Arming/disarming with remote command

VISO software enables to arm and disarm Alarm Zones with Remote commands, which are invoked by right clicking particular zone (e.g. in Map monitoring window) and then selecting *Remote Command*. Remote command can be included in Global command, which can be invoked manually in the same way as Remote command or automatically by selected events registered in the system. Global commands can be also invoked from VISO Mobile and VISO Web software. Global command can include multiple Remote commands and be consequently used to arm/disarm multiple Alarm Zones at once.

Remote command can be used only by VISO operator with proper rights. Such rights are defined by assignment of operator to Access User Person with proper Authorization(s) (e.g. for function [102]) at particular Alarm Zone. Such association of Person and operator is done in the properties of user in the tab *Remote management* in the field *Operator*. The most simple method to grant all Authorizations to operator is to assign such operator to Person equipped with Access Credential with enabled *Master exemption* option. Operators and their authorisations are explained in AN040 application note.

Arming with schedule

Alarm Zones in RACS 5 system can be automatically armed by controller based on weekly schedule. Such schedules are defined by indicating at what time arming would be triggered. Disarming is not controlled by schedule. In order to define schedule and assign it to Alarm Zone:

- In the navigation tree of VISO software double click *Schedules* command.
- In the opened window click *Add* button to create new schedule.
- Name the schedule, select *General Purpose Momentary Type* and close the window with *OK* button.
- In the bottom select *Calendar Days* tab and then *Edit* button.
- In the opened window define with right clicking at what time arming commands will be invoked and close the window with *OK* button.
- In the navigation tree of VISO software within particular MC16 access controller double click *Alarm Zones* command.
- Edit or add Alarm Zone with *Edit* or *Add* buttons.
- In *Auto-arming Schedule* field assign previously created schedule.
- Additionally in the same window click and expand *Auto-arming Options* and configure *Incoming Auto-arming Signaling Time*. This parameter defines when the warning on scheduled arming will be signalled at Access Points (readers) belonging to particular Alarm Zone. The warning is signalled on readers with blinking red LED STATUS indicators (without any sound).

Arming disabled

Arming can be blocked by input with the function *[105]: Disable Armed ON Mode Toggle*. When the input is activated then arming is disabled but in case of scheduled arming the delay defined by parameter *Auto-arming delay when zone not ready for arming* is started. When delay time elapses then the next arming attempt is started which can be repeatedly delayed if the input is still activated. The input with function *[105]* can be connected to third party system/device or used within RACS 5 system. For example, the input with connected door contact can be configured as multifunction and assigned with *[105]* and *[130]: Door contact* functions. In such scenario when door is opened then the door contact additionally prevents Alarm Zone arming.

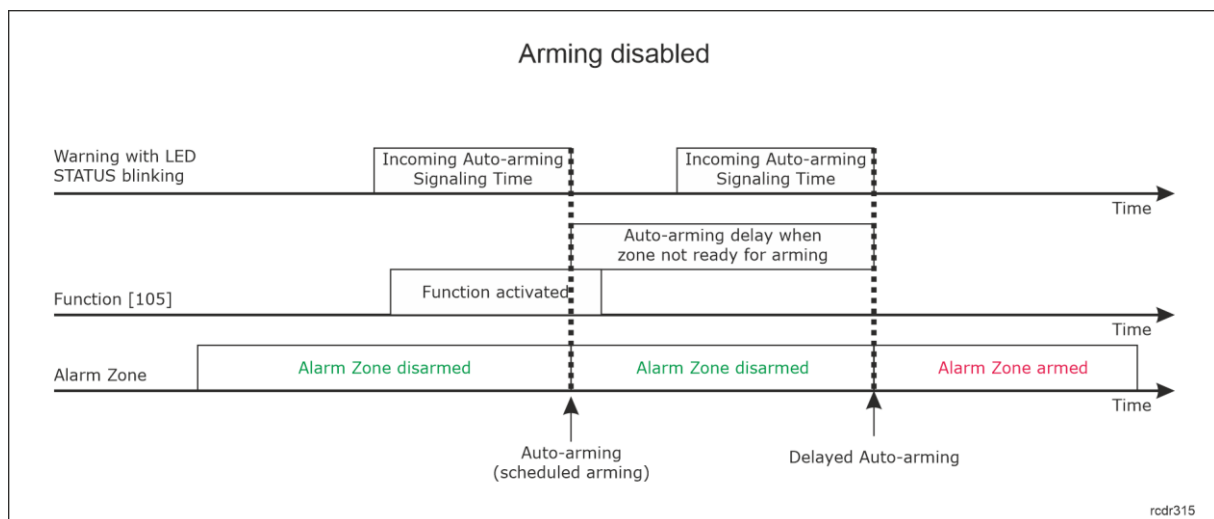

Auto-arming postponed

Auto-arming (scheduled arming) can be delayed with the function *[106]: Postpone Auto-arming*. This function contrary to the function *[105]* can be assigned not only to input but also to function key, Local command, Authentication Options at the level of Access Points, etc. If the function *[106]* is invoked during auto-arming warning i.e. within the time defined by the parameter *Incoming Auto-arming Signaling Time* then the next arming is attempted when the time defined by the parameter *Auto-arming delay on manual request* elapses.

Auto-arming can also be delayed by standard access granting if the option *Postpone auto-arming after physical access is granted* is enabled. In such scenario the user must be assigned not only with access authorisation but also with Basic Authorization for arming control or Advanced Authorisation for the function [106]: *Postpone Auto-arming*.

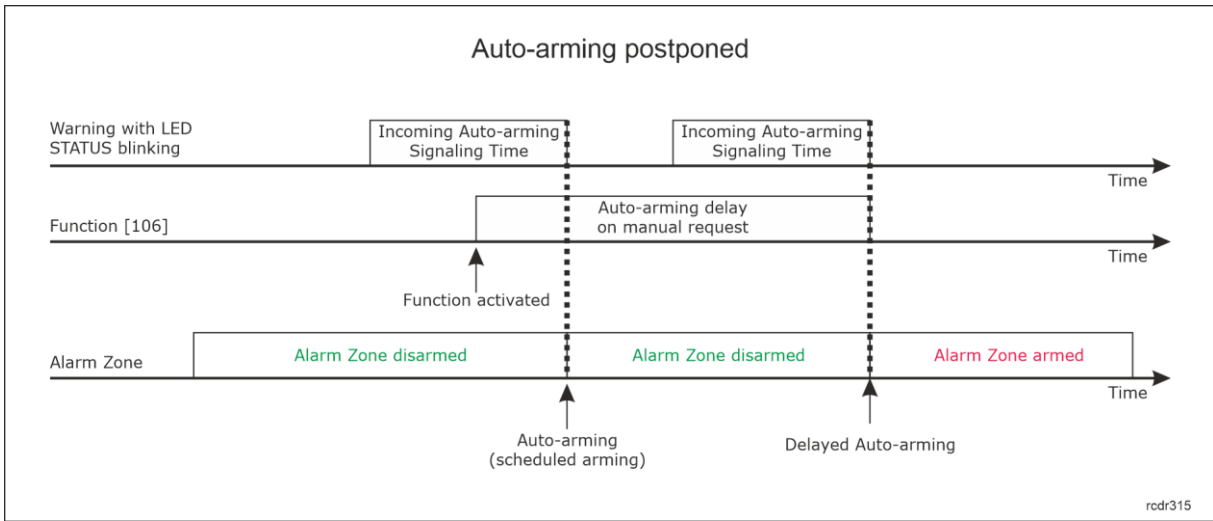

The screenshot shows the "Edit Alarm Zone" configuration window. The "Auto-arming Options" section is highlighted with a red border. The settings are as follows:

- General:** ID: 5, Name: C1_ALZ2, Keypad Shortcut: No shortcut, Parent: None, Auto-arming Schedule: None.
- Auto-arming Options:**
 - Incoming Auto-arming Signaling Time [min]: 5
 - Auto-arming delay when zone not ready for arming [min]: 5
 - Auto-arming delay on manual request [min]: 5
 - Postpone auto-arming after physical access is granted:
- Buttons:** OK and Cancel.

Hierarchy of Alarm Zones

RACS 5 system enables configuration of hierarchy for Alarm Zones in such way that when parent (master) zone is armed with any method then subordinate zones are armed automatically. This relation does not concern disarming where each zone must be disarmed individually. Additionally when the arming of subordinate zone is disabled e.g. with the function [105], then superordinate

zones cannot be armed. Hierarchy of Alarm Zones concerns zones defined within particular MC16 controller.

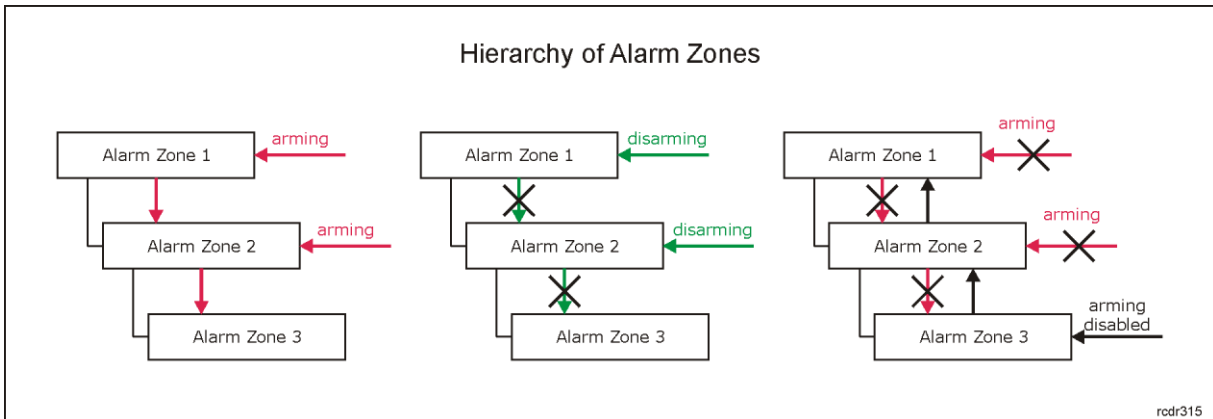

In order to define hierarchy between two Alarm Zones:

- Create Alarm Zone (superordinate).
- Create another Alarm Zone (subordinate) indicating in its properties which other Alarm Zone is Parent (superordinate) to it.

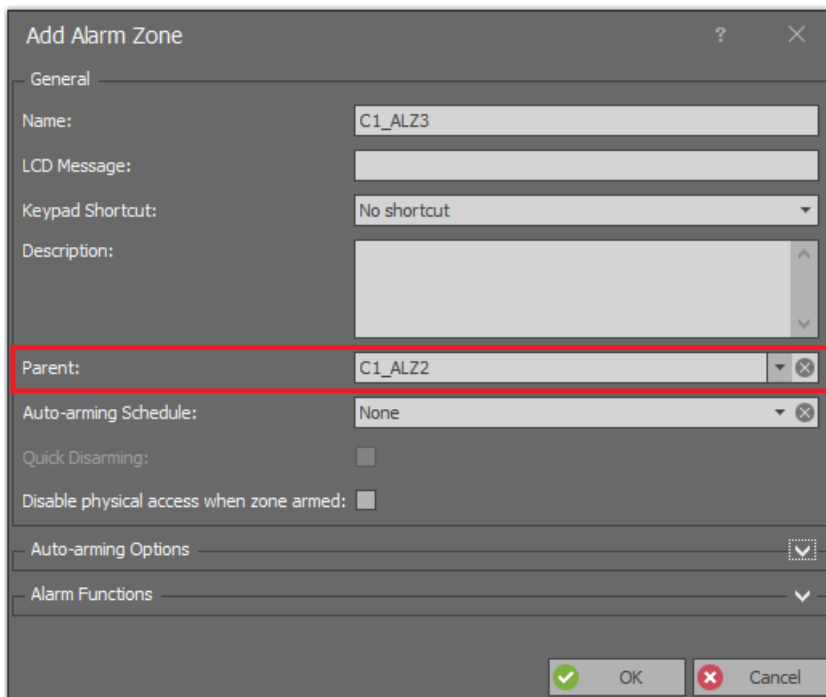

Global control of Alarm Zones

Particular Alarm Zone is managed by single MC16 controller. Nevertheless it is possible to arm/disarm multiple Alarm Zones configured at multiple controllers using single Access Point (reader). This can be achieved by means of Global commands, events and RACS 5 Communication Server operated in the background.

In order to configure global arming of two Alarm Zones from single readers where each zone is configured at individual controller:

- In the top menu select *Event Log* and then *Event Types* icon. In the opened window select *Add* and define new custom event type.

The 'Add Event Type' dialog box is shown with the following details:

- General:**
 - Code: 1000
 - Name:** Alarm Zones 1 & 2 Arming (highlighted with a red box)
 - Description: (empty text area)
 - Severity: Low
 - Category: (none)
 - Sound:
 - Alarm:
- Display Options:**
 - Font, Font style, Font size: (dropdown menus)
 - Font color: (color picker)
 - Font background color: (color picker)
 - Reset button
- Buttons: OK (green checkmark), Cancel (red X)

- Create two Alarm Zones, each within different access controller and assign them with Arming Points i.e. Access points which are usually created when Access Doors are configured.
- In the navigation tree of VISO software within particular MC16 access controller double click *Automation Nodes* command and in the opened create a node defining its *Default Time* and assigning previously created event. Close the window with *OK* button.

The 'Add Automation Node' dialog box is shown with the following details:

- General:**
 - Name: C1_AN2
 - Group: (none)
 - LCD Message: (empty text area)
 - Keypad Shortcut: No shortcut
 - Description: (empty text area)
- Triggering Options:**
 - Default Time:** 1 s (highlighted with a red box)
 - Default Delay: 0 s
 - Activation Extending:
- Additional Options:** (collapsed)
- Events:**
 - Register event when node is switched ON:
 - Node ON Event:** [1000]: Alarm Zones 1 & 2 Arming (highlighted with a red box)
 - Register event when node is switched OFF:
 - Node OFF Event: [658]: Automation Node Switched OFF
- Buttons: OK (green checkmark), Cancel (red X)

- For created node in the bottom select *Local Commands* tab, create new command with the button  and assign the function [162]. Enable the option *Authorisation for Object* required to determine the scope of Authorisation required to activate the node and consequently arm both zones.

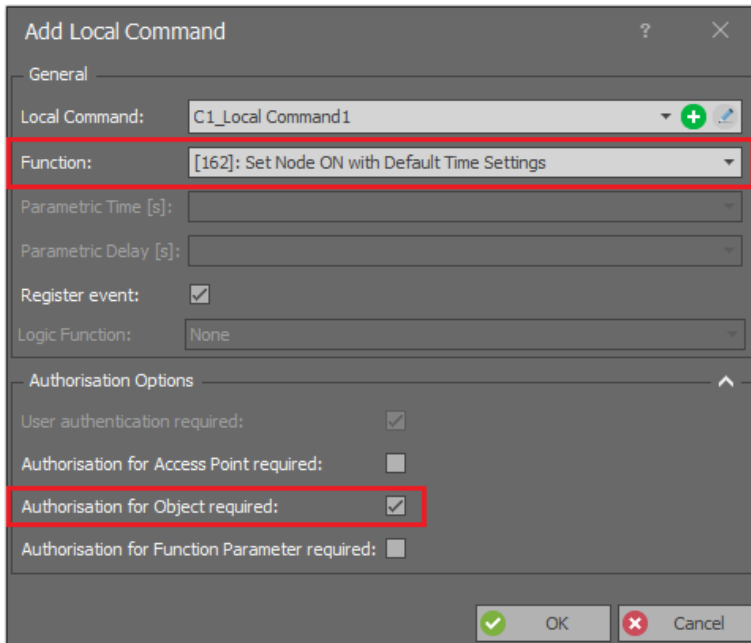

- Within the same MC16 access controller double click *Access Points* command and select Access Point which will be used to arm both Alarm Zones at once. Usually Access Point belonging to Alarm Zone is selected for that purpose so the Armed mode can be observed on reader’s LED.
- In the bottom select *Authentication Options* tab, *Edit* button and then in *Double Authentication* tab select previously created Local Command. Therefore single use of proximity card or PIN can still be reserved for access granting while double card reading or PIN entering will be reserved for arming. Close the window with OK button.

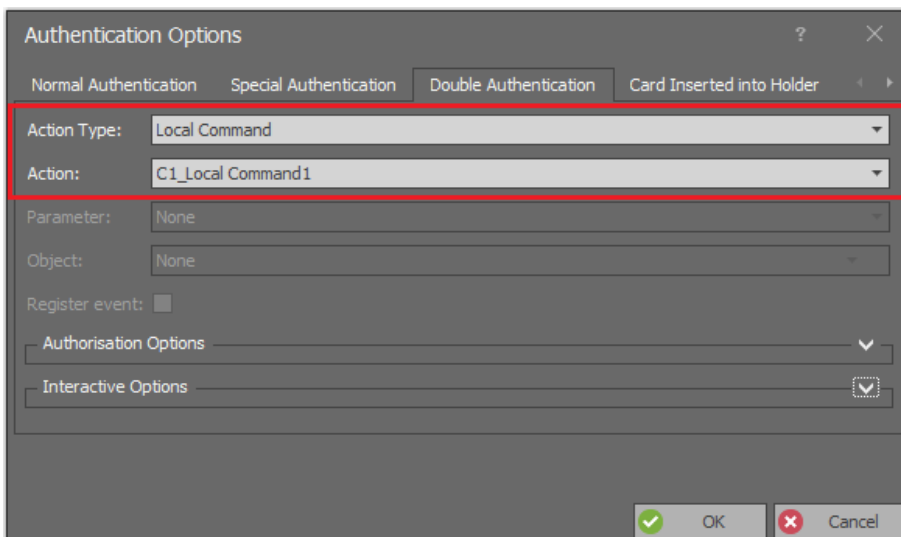

- In the navigation tree of VISO software double click *Global Commands* and in the opened window select *Add* to create new command. Close the window with OK button.
- In the bottom select *Remote commands* tab and *Add* button to define two commands for arming of both Alarm Zones.

Details

Main Remote Commands Local Commands Schedules

+ Add Edit Select All Delete Refresh Report

ID	Object Type	Object Name	Function
1	Alarm Zone	C1_ALZ2	[103]: Set Armed ON Mode
2	Alarm Zone	C1_ALZ3	[103]: Set Armed ON Mode

- In the top menu again select *Event Log* command and *Event Types* icon. For previously created event [1000] in the bottom select *Actions* tab and *Add* button.
- In the opened window select *Execute Global Command* and indicate previously created command. Close the window with *OK* button.

- Upload settings to controllers.

In described above scenario, double card reading or PIN entering activates Automation Node by means of Local Command. Node activation generates the event which triggers Global Command

and consequently both zones becomes Armed by Remote Commands. Disarming as well as arming of multiple Alarm Zones from multiple Access Points (readers) can be configured similarly. Global arming/disarming requires computer with Communication Server operated in the background. The server is available within RogerSVC software package.

Global arming of Alarm Zones as in the scenario above requires configuration of Advanced Authorisation for function [162]. In order to define such Authorisation for further assignment to user(s):

- In the navigation tree of VISO software expand *Authorisations* command, double click *Advanced Authorisations* and in the opened window select *Add* button.
- In the next window select the function [162]. Close the window with *OK* button.
- For created Authorisation create Positive Rule as below.
- Assign newly created Authorisation to a user e.g. by means of wizard.

The image shows two screenshots of software configuration windows. The left window is titled "Add Advanced Authorisation" and the right is "Add Rule".

Add Advanced Authorisation window:

- General:** Enabled: ; Name: "Authorisation for Node of Alarm Zone 1"; Type: "Main"; Valid from: "[Not limited]"; Valid to: "[Not limited]"; Description: (empty text area).
- Details:** Refers to: "Function"; Action: "[162]: Set Node ON with Default Time Settings" (highlighted with a red box).
- Advanced Options:** Includes authorisations for all rules: ; Includes authorisation for all Access Points: ; Includes authorisation for all Function Parameters: .

Add Rule window:

- General:** Enabled: ; Type: "Object".
- When:** Time Range: "Always"; Schedule: (empty).
- Where:** Range: "Specified"; Type: "Automation Node"; Value: "[2]: C1_AN2" (highlighted with a red box).

Integration of RACS 5 with alarm systems

The main concept of access control system and intruder alarm system integration is to associate alarm zones of both systems i.e. to link armed modes of readers and detectors. Following hardware integration concepts are available in RACS 5:

Method I

In this method, both access control and alarm system are operated with the same priority. Arming/disarming in one of the systems results in activation of an output in order to trigger arming/disarming in the other system. In case RACS 5 not only input function [102] but also [103] and [104] functions can be used and instead of output function [44] also function [42] and [43] can be applied. This method does not include feedback connection so if arming is initiated in RACS 5 system then there is no feedback information if arming in alarm system actually occurred as alarm system could be not ready for such arming in certain moment.

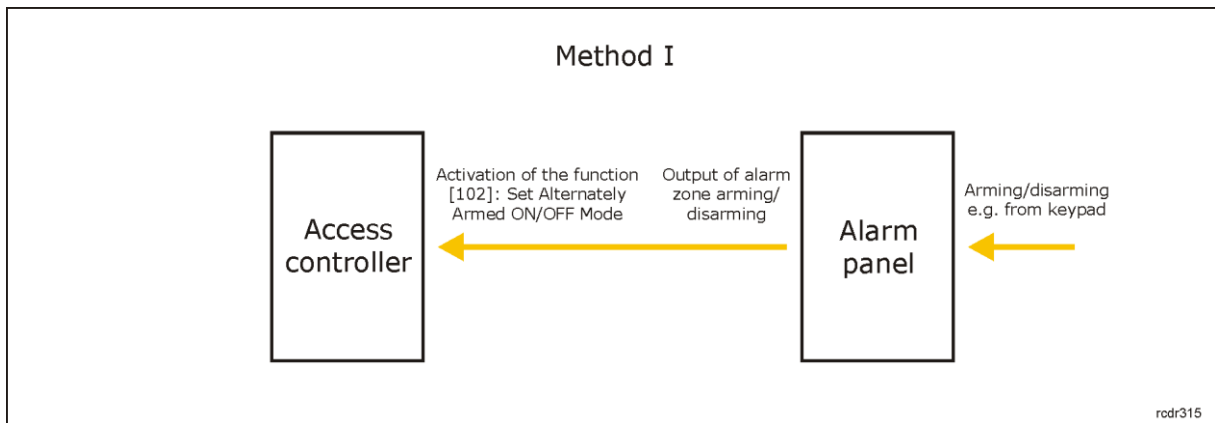
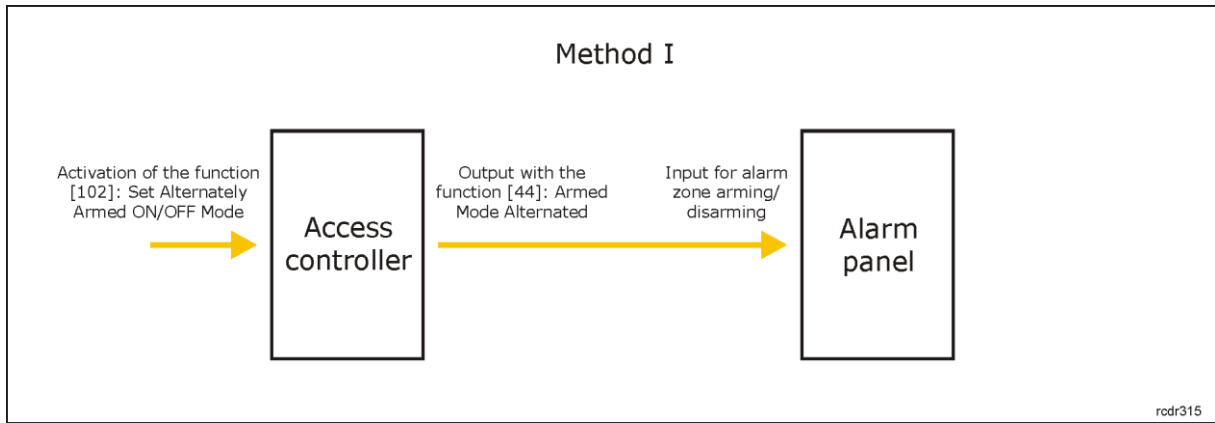

Method II

In this method, alarm system has higher priority than access control system in regard of alarm zones arming/disarming. If arming/disarming is initiated in RACS 5 system then request is sent to alarm system and actual arming/disarming in access control system depends on feedback from alarm system. For initiation of arming/disarming on RACS 5 side there can be used input functions [107]..[109] and output functions [45]..[47] while actual arming/disarming is ensured by impulse generated by alarm system on inputs with functions [102]..[104].

In this method such functionalities of RACS 5 system as Alarm Zone schedules, arming/disarming disabling and postponing as well as hierarchies of Alarm Zones are not applied. If necessary they should be provided by alarm system.

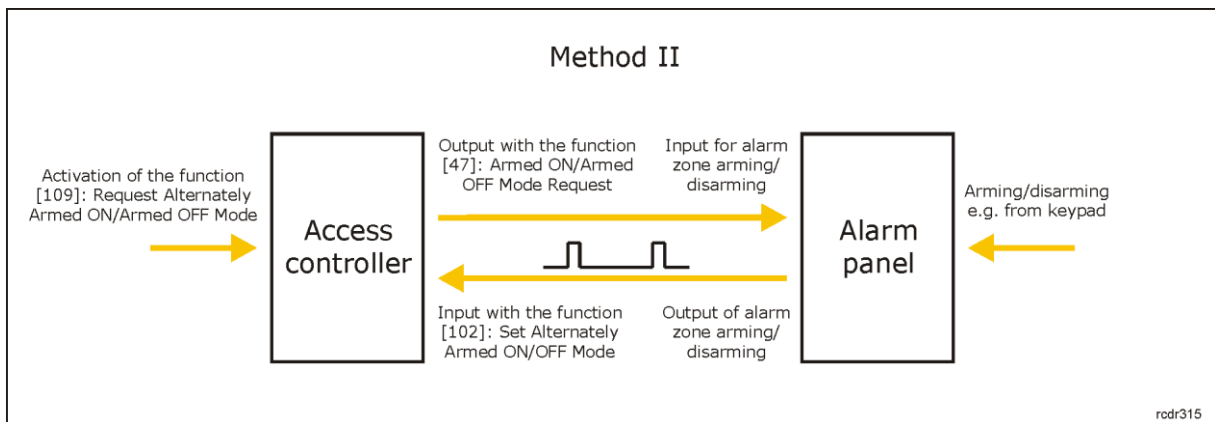

Shortened configuration procedure for method 2:

- Configure RACS 5 access control system according to AN006 Application note.
- Create Alarm Zone with Arming Points

- Within the zone configure output with the function [47]: *Armed ON/Armed OFF Mode Request* and connect it to the input for alarm zone arming/disarming at alarm control panel.
- In the same zone configure input with the function [102]: *Set Alternately Armed ON/OFF Mode* and connect it to the output representing alarm zone arming/disarming at alarm control panel. The signal from alarm control panel should be pulse with minimal duration of 50ms.
- Define Alarm Zone arming/disarming method in RACS 5 system. In case of arming/disarming with user card at Access Point (reader), assign the function [109]: *Request Alternately Armed ON/OFF Mode for Double Authentication* in *Authentication Options* of Access Points. In such case double card reading shall generate arming/disarming request to alarm system.
- Create Basic Authorisation to control arming/disarming of created Alarm Zone or create Advanced Authorisation for function [109] at particular Alarm Zone.
- Assign the Authorisation to user's Access Credentials. *Add Person Online* or *Edit Person Online* wizard can be used for that purpose.
- Upload settings to controller.

Method III

In this method similarly as in previous one, alarm system has higher priority than access control system in regard of alarm zones arming/disarming. Functioning is similar as in method II and it is based on feedback but arming and disarming in RACS 5 is controlled by input with function [101]: *Armed ON Mode Toggle*. In such scenario alarm system should activate the input with function [101] as long as associated Alarm Zone in RACS 5 is supposed to be armed and deactivate input with function [101] as long as associated Alarm Zone in RACS 5 is supposed to be disarmed.

In this method such functionalities of RACS 5 system as Alarm Zone schedules, arming/disarming disabling and postponing as well as hierarchies of Alarm Zones are not applied. If necessary they should be provided by alarm system.

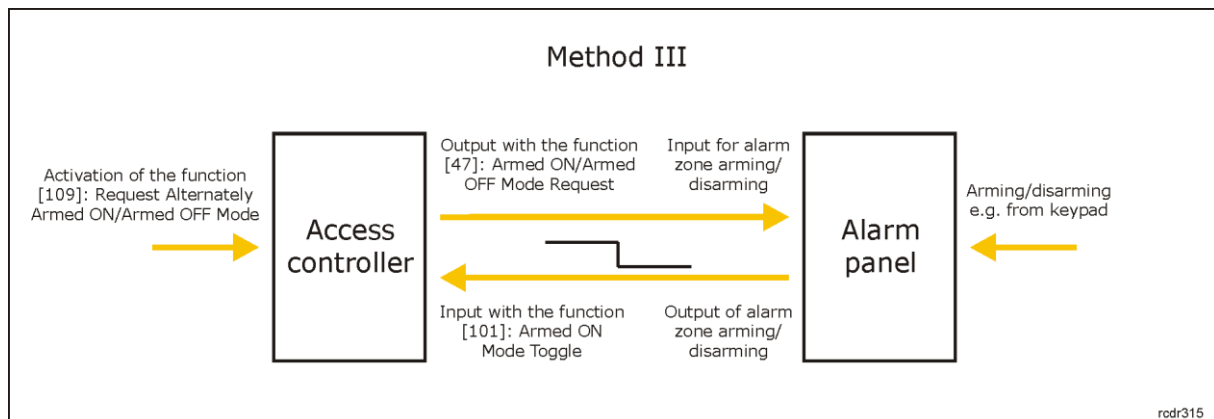

Additional control of LED indicators

Armed and disarmed mode of Alarm Zone is presented on LED indicators of readers belonging to particular Alarm Zone. Red LED ARM indicates zone arming while green LED DISARM indicates zone disarming. At the same time red LED ARM indicators on all readers in RACS 5 are by default switched on even if particular reader is not assigned to any Alarm Zone. As in some scenarios this might be confusing for users, it is possible to switch these indicators off especially on readers which do not belong to any Alarm Zone. In order to switch LED ARM and LED DISARM off:

- In the navigation tree of VISO software within particular MC16 access controller double click *Outputs* command and then *Add* button.
- In the opened window select LED ARM or LED DISARM output on particular reader. Close the window with *OK* button.
- Upload settings to controller.

In some installation it is necessary to hide Armed Mode signalling on LED indicators. In order to signal Alarm zone arming only for a few seconds after actual arming:

- In the navigation tree of VISO software within particular MC16 access controller double click *Alarm Zones* command, in the bottom select *Outputs* tab and then *Add* button.
- In the opened window select the button , then LED ARM indicator of particular reader and assign the function *[042]: Armed ON Mode Set*.
- In the field *Pulse Time* set 5 s so LED ARM (red) indicator would be switched only for 5 seconds after Alarm zone is armed and then it would be switched off.

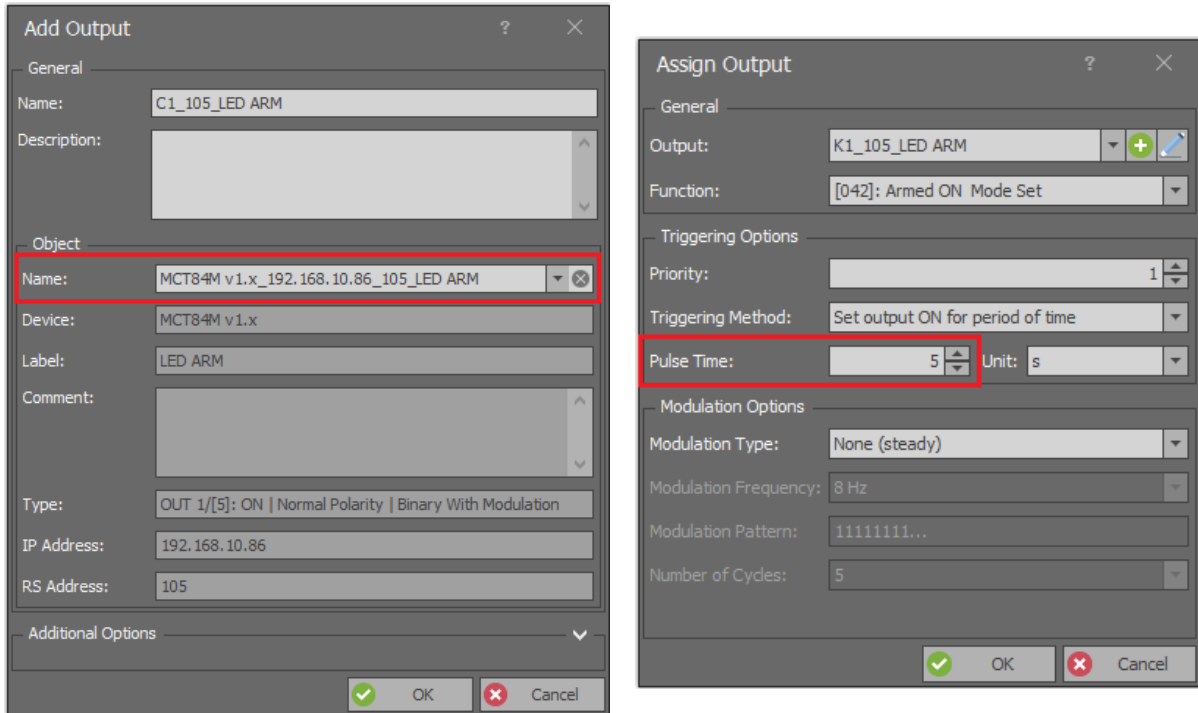

Configuration of output line parameters for alarm system control

Alarm systems which are offered on the market may have various requirements regarding signals at their inputs. RACS 5 system enables the configuration of signal modulation at its outputs including number and duration of pulses. These parameters are configured when output is assigned to Alarm Zone.

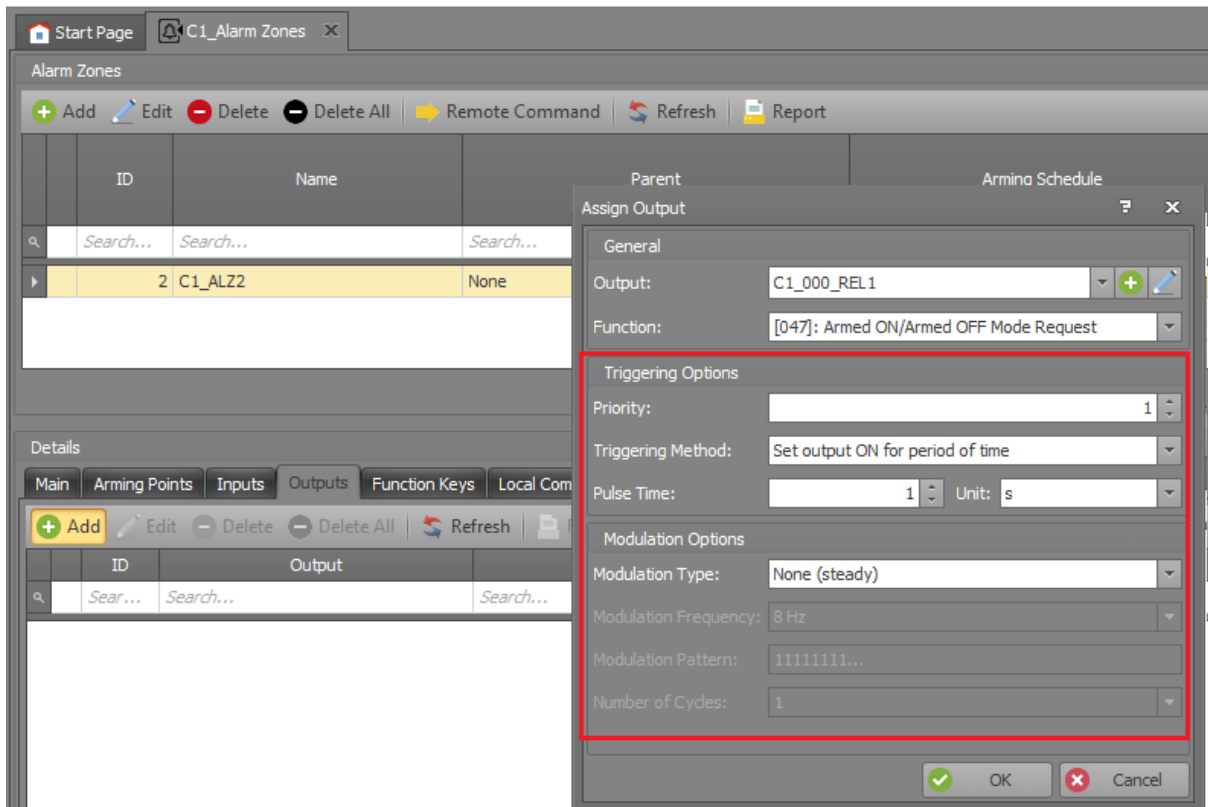

Monitoring/Maps

VISO management software offers visualization, monitoring and remote control of such objects as Alarm Zone, Access Doors, CCTV Devices, inputs, outputs, etc. on the level of Maps. The software enables to read statuses and alarms, view events and start Remote Commands.

In RACS 5 v1 system, the Maps module was offered free of charge in the standard version of VISO software. In RACS 5 v2 system the Maps module was significantly developed and it is offered as licensed module to be used mainly within VISO SMS system. More information on this subject is given in AN055 application note.

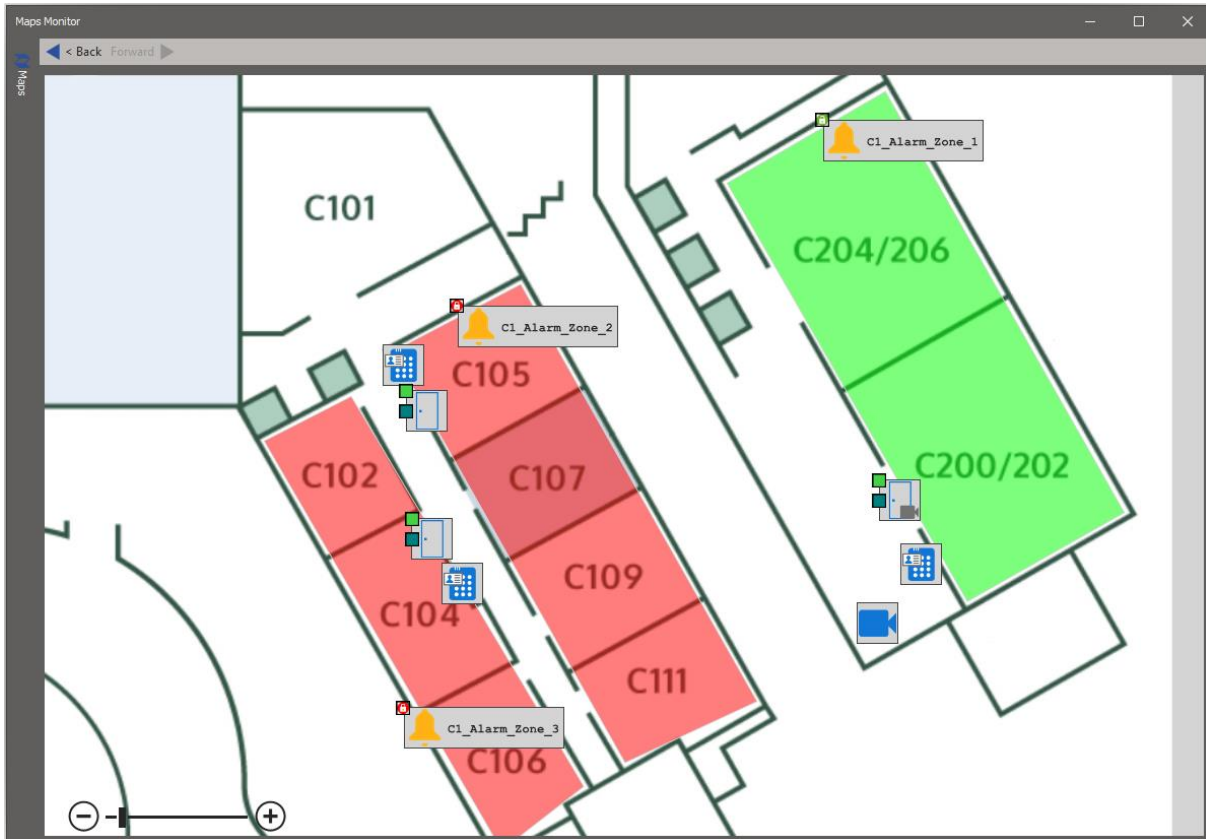

Additionally, the status of Alarm Zone can be controlled in the Alarm Zones Monitor which is available after selection of *System Monitors* in the top menu of VISO software.

Appendix

Input functions on the level of Alarm Zone

No.	Name	Description
101	Armed On Mode Toggle	As long as the input with function [101] is activated then Alarm Zone is maintained armed and other disarming methods are disabled. When the input is deactivated then the Alarm Zone becomes disarmed but arming with other methods is not blocked.
102	Set Alternately Armed ON/ Armed OFF Mode	When the input with function [102] is activated then Alarm Zone is switched to opposite mode.
103	Set Armed On Mode	When the input with function [103] is activated then Alarm Zone is switched to armed.
104	Set Armed OFF Mode	When the input with function [104] is activated then Alarm Zone is switched to disarmed.
105	Disable Armed ON Mode Toggle	As long as the input with function [105] is activated then Alarm Zone arming is disabled.
106	Postpone Auto-arming	When the input with the function [106] is activated during time specified by the parameter <i>Incoming Auto-arming Signaling Time</i> then auto-arming (scheduled arming) is postponed by the time specified by the parameter <i>Auto-arming Delay on Manual Request</i> .

107	Request Armed ON Mode	When the input with function [107] is activated then outputs with function [045]: <i>Armed ON Mode Request</i> and function [047]: <i>Armed ON/ Armed OFF mode Request</i> are activated.
108	Request Armed OFF Mode	When the input with function [108] is activated then outputs with function [046]: <i>Armed OFF Mode Request</i> and function [047]: <i>Armed ON/ Armed OFF mode Request</i> are activated.
109	Request Alternately Armed ON/ Armed OFF Mode	When the input with function [109] is activated then output with function [047]: <i>Armed ON/ Armed OFF mode Request</i> is activated. Additionally if the Alarm Zone is armed then the output with function [046]: <i>Armed OFF Mode Request</i> is activated and if the Alarm Zone is disarmed then the output with function [045]: <i>Armed ON Mode Request</i> is activated.

Output functions on the level of Alarm Zone

No.	Name	Description
041	Armed ON Mode Status	The output is activated as long as Alarm Zone is armed and deactivated as long as Alarm Zone is disarmed. The function operates inversely to [048] function.
042	Armed ON Mode Set	The output is activated when Alarm Zone becomes armed. Activation time and modulation are configurable.
043	Armed OFF Mode Set	The output is activated when Alarm Zone becomes disarmed. Activation time and modulation are configurable.
044	Armed Mode Alternated	The output is activated when Alarm Zone is switched to opposite Armed Mode. Activation time and modulation are configurable.
045	Armed ON Mode Request	The output is activated by inputs with functions [107] and [109]. Activation time and modulation are configurable.
046	Armed OFF Mode Request	The output is activated by inputs with functions [108] and [109]. Activation time and modulation are configurable.
047	Armed ON/ Armed OFF mode Request	The output is activated by inputs with functions [107], [108] and [109]. Activation time and modulation are configurable.
048	Armed OFF Mode Status	The output is activated as long as Alarm Zone is disarmed and deactivated as long as Alarm Zone is armed. The function operates inversely to [041] function.
087	Incoming Auto-arming Status	The output is activated as long as warning before Alarm Zone auto-arming is signalled.
100	Incoming Auto-arming ON	The output is activated when warning before Alarm Zone auto-arming is started

Contact:
Roger sp. z o.o. sp.k.
82-400 Sztum
Gościszewo 59
Tel.: +48 55 272 0132
Fax: +48 55 272 0133
Tech. support: +48 55 267 0126
E-mail: support@roger.pl
Web: www.roger.pl