

Roger Access Control System

MCX2-BRD / MCX8-BRD Installation Manual

Firmware version: 2.0.30.266 and newer

Hardware version: 2.0

Document version: Rev. G



This document contains minimum information that is necessary for initial setup and installation of the device. The detailed description of configuration parameters and functionalities is specified in respective Operating Manual available at www.roger.pl.

INTRODUCTION

The expander is designed for operation with MC16 access controller (RACS 5 system). Factory new expander is configured with default settings including ID=100 address.

DEVICE CONFIGURATION

The expander can be configured in regard of various parameters (including address) in order to adapt it to the requirements of specific installation. Device can be configured from VISO v2 management software or RogerVDM utility software.

Note: Remote configuration of device from VISO v2 software is possible only if jumper is placed on JP7 contacts (fig. 4/5). If the jumper is removed then such configuration is blocked. In case of factory new device, jumper is placed on JP7 contacts.

CONFIGURATION WITH VISO v2 PROGRAM

In RACS 5 v2 system the expander can be installed at site without previous configuration. According to AN006 application note, its address and other settings can be configured from VISO v2 management software and during such configuration the access to its service contacts (fig. 4/5) is not required.

CONFIGURATION WITH ROGERVDM PROGRAM

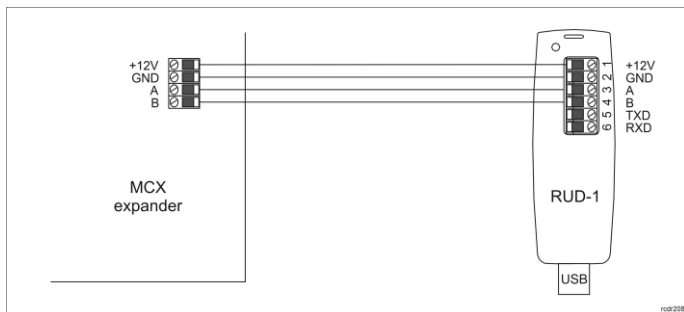

Fig. 1 Connection of the expander to RUD-1 interface (configuration)

Programming procedure with RogerVDM software:

1. Connect the device to RUD-1 interface (fig. 1) and connect the RUD-1 to computer's USB port.
2. Remove jumper from JP7 contacts (fig. 4/5) if it is placed there.
3. Restart the device (press RESET button or switch power supply off and on) and LED PWR will pulsate. Then within 5 seconds place jumper on JP7 contacts.
4. Start RogerVDM program, select MCX v2.x device, v2.0 firmware version, RS485 communication channel and serial port with RUD-1 interface.
5. Click *Connect*, the program will establish connection and will automatically display *Configuration* tab.
6. Enter unoccupied RS485 address in range of 100-115 and other settings according to requirements of specific installation.
7. Click *Send to Device* to update the configuration.
8. Optionally make a backup by clicking *Send to File...* and saving settings to file on disk.
9. Disconnect from RUD-1 interface and leave jumper on JP7 contacts to enable further configuration of device from VISO v2 software or remove jumper from JP7 contacts to block such remote configuration.

MANUAL ADDRESSING

The RS485 address of expander configured with VISO v2 or RogerVDM is a software address. Alternatively a hardware RS485 address of MCX8-BRD expander can be configured with jumpers and such address has higher priority than software address.

Note: Each time the hardware RS485 address is modified the device must be restarted

If jumper is not placed on JP5 contacts then addresses in range 201-215 are set.

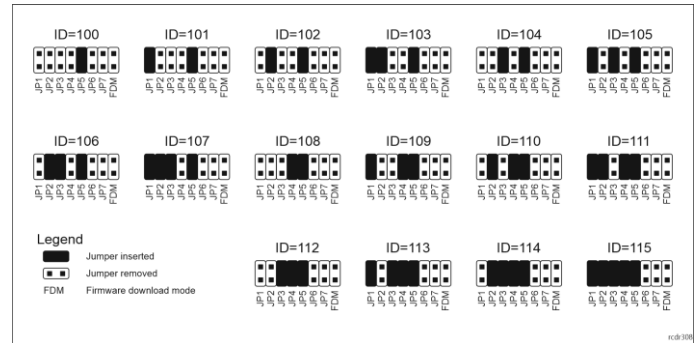

Fig. 2 Manual addressing of MCX8-BRD expander

FIRMWARE UPDATE

The firmware of device can be changed to newer or older version. The update requires connection to computer with RUD-1 interface (fig. 3) and starting RogerVDM software. The latest firmware file is available at www.roger.pl.

Firmware update procedure:

1. Connect the device to RUD-1 interface (fig. 3) and connect the RUD-1 to computer's USB port.
2. Place jumper on FDM contacts (fig. 4/5).
3. Restart the device (press RESET button or switch power supply off and on).
4. Start RogerVDM program and in the top menu select *Tools* and then *Update firmware*.
5. In the opened window select device type, serial port with RUD-1 interface and path to firmware file (*.hex).
6. Click *Update* to start firmware upload with progress bar in the bottom.
7. When the update is finished, disconnect from RUD-1 interface and remove jumper from FDM contacts.

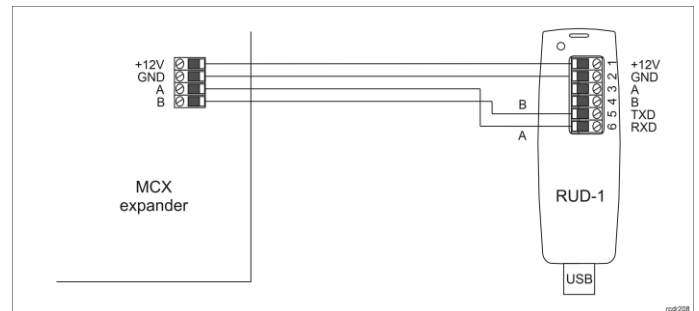

Fig. 3 Connection of the expander to RUD-1 interface (firmware update)

APPENDIX

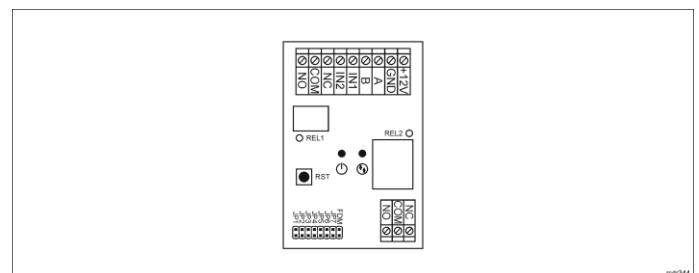

Fig. 4 MCX2-BRD expander

Table 1. MCX2-BRD screw terminals	
Screw terminal	Description
+12V	12VDC power supply
GND	Ground
A*	RS485 bus, line A
B*	RS485 bus, line B

IN1	IN1 input line
IN2	IN2 input line
NC	RELx relay output (NC)
COM	RELx relay common terminal
NO	RELx relay output (NO)

* In older versions of the MCX2-BRD expander, terminals A and B may be marked on the board respectively as IO1 and IO2.

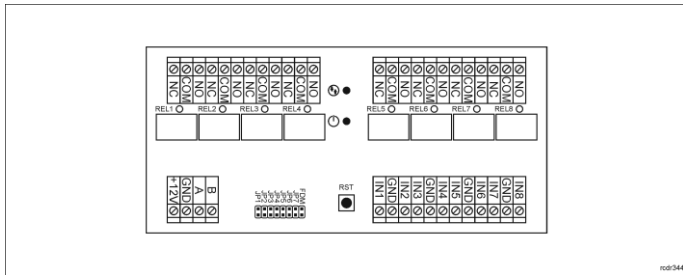

Fig. 5 MCX8-BRD expander

Screw terminal	Description
+12V	12VDC power supply
GND	Ground
A	RS485 bus, line A
B	RS485 bus, line B
NC	RELx relay output (NC)
COM	RELx relay common terminal
NO	RELx relay output (NO)
IN1..IN8	IN1..IN8 input line

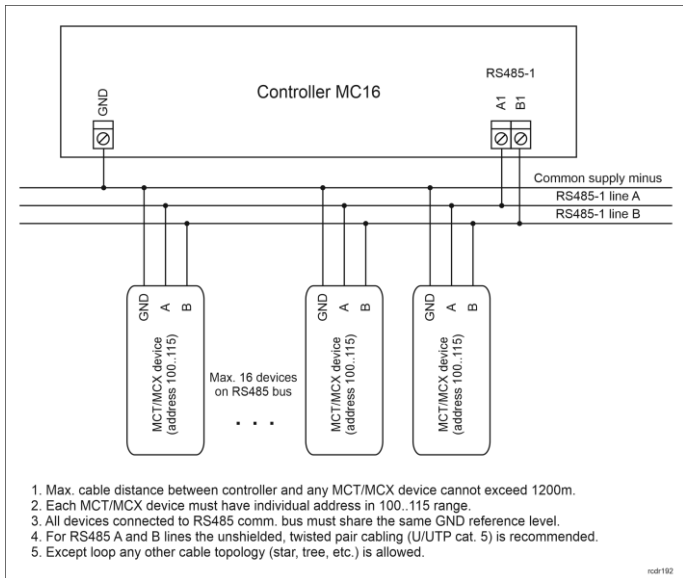
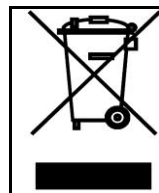

Fig. 6 Connection of readers and expanders to MC16 access controller

Supply voltage	Nominal 12VDC, min./max. range 10-15VDC
Current consumption (average)	30mA (when relays off)
Inputs	MCX2-BRD: Two (IN1, IN2) MCX8-BRD: Eight (IN1..IN8) parametric inputs internally connected to the power supply plus (+12V) through a 15kΩ resistor, approx. 3.5V triggering level when configured as NO or NC.
Relay outputs	MCX2-BRD: Two relay outputs REL1: 30VDC/1,5A REL2: 30VDC/5A MCX8-BRD: Eight relay outputs: REL1..REL8: 30VDC/1.5A Each with single NO/NC contacts.
Distances	Up to 1200 m between controller and expander (RS485)
IP Code	IP20
Environmental class (according to EN 50133-1)	Class I, indoor general conditions, temperature: +5°C to +40°C, relative humidity: 10 to 95% (no condensation)
Dimensions W x S x G	MCX2-BRD: 80 x 54 x 20 mm MCX8-BRD: 72 x 155 x 20 mm
Weight	MCX2-BRD: 50g MCX8-BRD: 115g
Certificates	CE



This symbol placed on a product or packaging indicates that the product should not be disposed of with other wastes as this may have a negative impact on the environment and health. The user is obliged to deliver equipment to the designated collection points of electric and electronic waste. For detailed information on recycling, contact your local authorities, waste disposal company or point of purchase. Separate collection and recycling of this type of waste contributes to the protection of the natural resources and is safe to health and the environment. Weight of the equipment is specified in the document.

Contact:
Roger Sp. z o. o. sp. k.
82-400 Sztum
Gościszewo 59
Tel.: +48 55 272 0132
Fax: +48 55 272 0133
Tech. support: +48 55 267 0126
E-mail: support@roger.pl
Web: www.roger.pl