

*Roger Access Control System*

## RFT1000 in third party systems

### User Manual

*Firmware version: 1.2*

*Hardware version: 1.1*

*Document version: Rev. C*

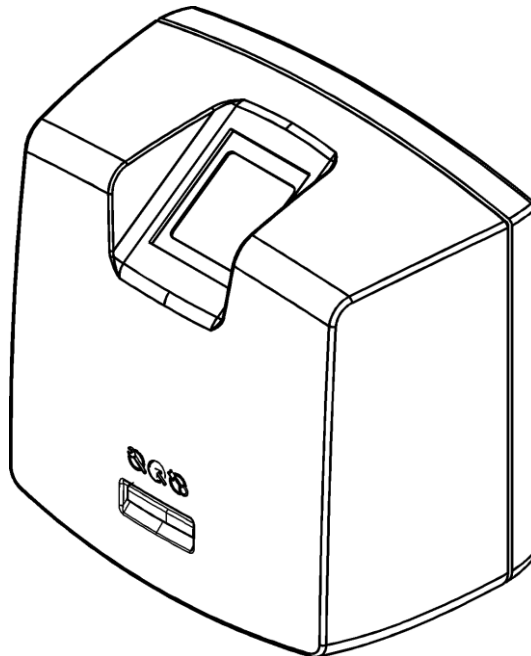

## Contents

<b>1. Introduction .....</b>	<b>3</b>
<b>2. Description and specification .....</b>	<b>3</b>
<b>3. Installation .....</b>	<b>4</b>
3.1 Terminals and connection diagrams .....	4
3.2 LED indicators .....	6
3.3 Power supply .....	6
3.4 Inputs .....	6
3.5 Wall mounting.....	7
3.6 Use/installation guidelines.....	8
<b>4. Configuration.....</b>	<b>8</b>
4.1 Connection and configuration of communication with reader .....	9
4.2 Wiegand interface .....	10
4.3 Configuration of inputs and LED indicators .....	10
4.4 Recognition modes .....	12
4.4.1 Mode 1:N .....	12
4.4.2 Mode 1:1 .....	12
4.5 Users.....	12
4.5.1 Enrolment of users in 1:N mode .....	12
4.5.2 Enrolment of users in 1:1 mode .....	13
4.5.3 User identification.....	14
4.6 Card code .....	15
4.6.1 SSN code programming .....	15
4.7 Configuration export/import.....	16
4.8 Encrypted communication.....	16
4.9 Full memory reset .....	16
4.10 Firmware update .....	17
<b>5. Ordering information.....</b>	<b>17</b>
<b>6. Product history .....</b>	<b>17</b>

# 1. INTRODUCTION

Note: Factory new RFT1000 reader is uploaded with firmware v1.3. The manual describes the application of RFT1000 with firmware v1.2 in third party systems. Such firmware can be downloaded from [www.roger.pl](http://www.roger.pl) and uploaded to reader according to section 4.10 below.

This manual contains minimum information that is necessary to properly install and then configure RFT1000 fingerprint readers by means of RogerVDM software. The purpose of the manual is to describe use of RFT1000 readers beyond RACS system in any third party application requiring user identification by means of fingerprints and/or MIFARE® proximity card. The application of RFT1000 reader in Roger's RACS systems is described in dedicated documents which are available at [www.roger.pl](http://www.roger.pl).

## 2. DESCRIPTION AND SPECIFICATION

RFT1000 reader operates as terminal for master device (controller) and is equipped with fingerprint scanner and MIFARE proximity card reader. RFT1000 reader can be configured by means of RogerVDM software through Ethernet port or RS485 port and the communication is encrypted with AES128 CBC standard. Whereas the communication between RFT1000 reader and master device (controller) is performed by means of Wiegand interface.

The reader can store up to 1900 fingerprint templates. User can be identified by comparison of his fingerprints with fingerprint templates recorded in reader's memory (1:N mode) or by comparison of his fingerprints with fingerprint templates recorded in MIFARE Classic card memory (1:1 mode).

<b>Table 1. Specification</b>	
Maximum number of users/fingerprint templates	1900
Fingerprint identification modes	1:N mode – fingerprint templates are recorded in reader memory 1:1 mode – fingerprint templates are recorded on MIFARE Classic cards
Proximity cards	MIFARE Ultralight/Classic
Supply voltage	Nominal 12VDC, min./max. range 10-15VDC
Avg. current consumption	100 mA for 12VDC
Inputs	Two (IN1,IN2) NO inputs, electrically biased to +12V via 15kΩ resistor, triggering level app. 3.5V
Ethernet	10BASE-T 10/100Mb Ethernet communication port
Port RS485	RS485 communication port
Interfaces	Wiegand 26..66 bit
Tamper	Isolated contact, NC type, 24V/50 mA rated
Environmental class (according to EN 50131-1)	Class I, indoor general conditions, temperature: +5°C to +40°C, relative humidity: 10 to 95% (no condensation)
IP code	IP41
Dimensions H x W x D	85mm x 85mm x 52mm
Weight	160g
Certificates	CE

### 3. INSTALLATION

#### 3.1 Terminals and connection diagrams

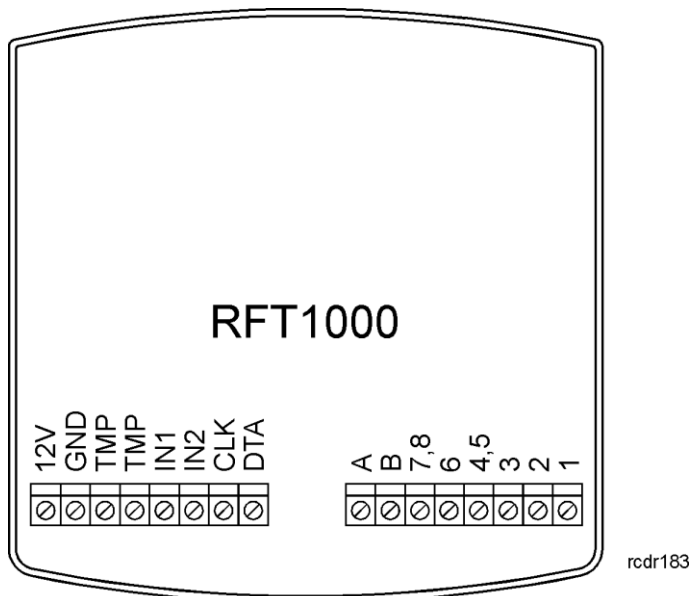

Fig. 1 RFT1000 terminals

Table 2. RFT1000 terminals	
Terminal	Description
12V	Positive power supply contact, 12VDC
GND	Negative power supply contact and reference potential for RS485 communication bus and input lines
TMP	Tamper switch, 24V/50mA
TMP	Tamper switch, 24V/50mA
IN1	IN1 input line
IN2	IN2 input line
CLK (D0)	DATA0 Wiegand line
DTA (D1)	DATA1 Wiegand line
A	RS485 communication bus (line A)
B	RS485 communication bus (line B)
7,8	Ethernet port terminal
6	Ethernet port terminal
4, 5	Ethernet port terminal
3	Ethernet port terminal
2	Ethernet port terminal
1	Ethernet port terminal

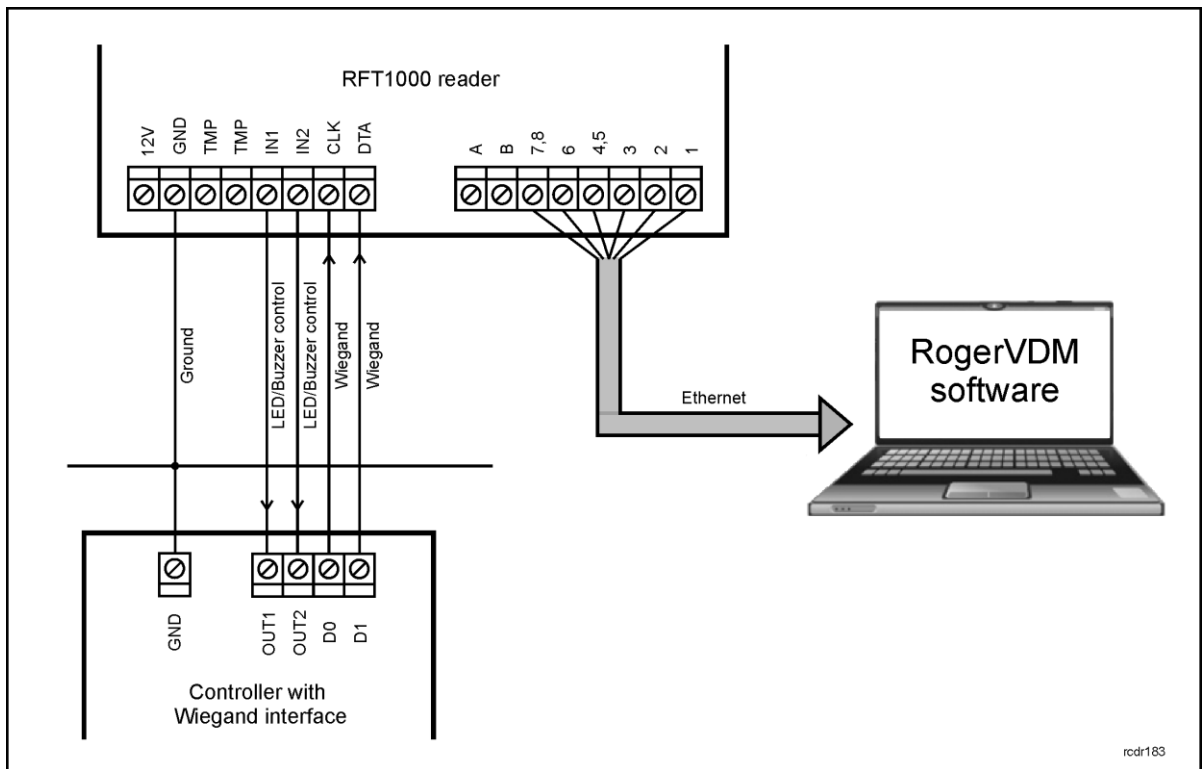

Fig. 2 Connection diagram for RFT1000 and master device (controller) - configuration through Ethernet port (recommended)

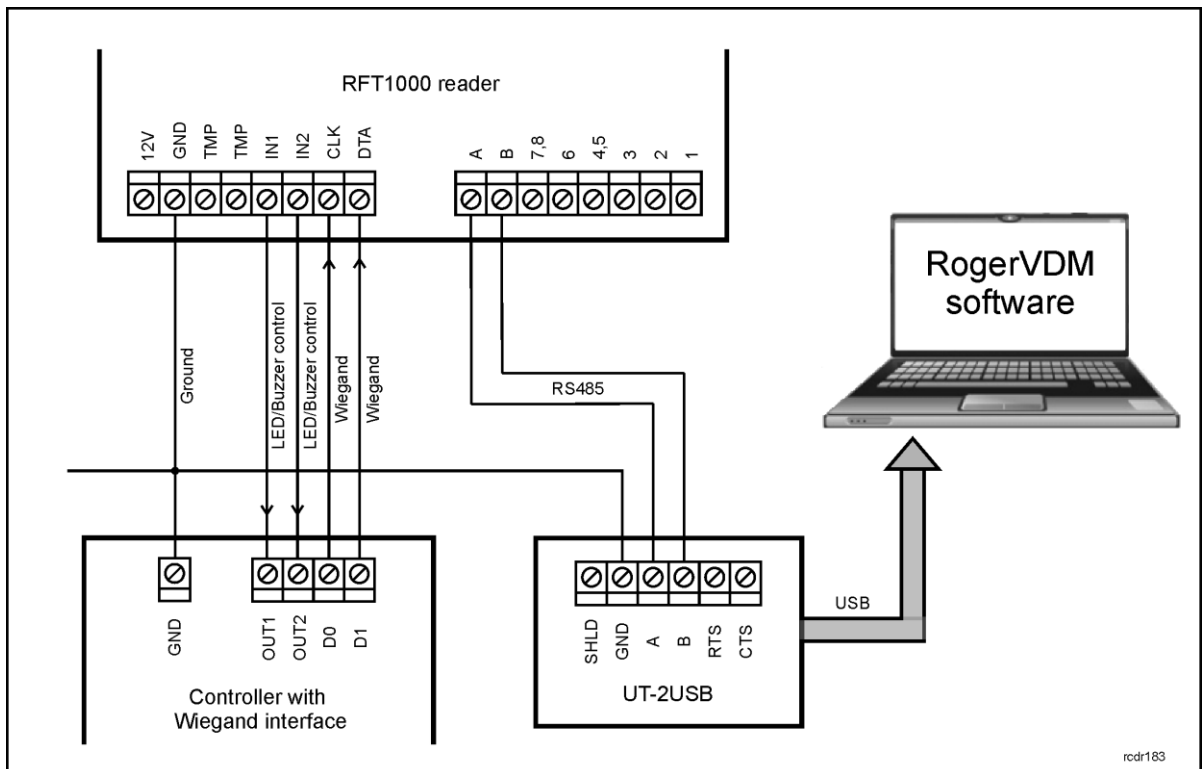





Fig. 3 Connection diagram for RFT1000 and master device (controller) - configuration through RS485 port

## 3.2 LED indicators

RFT1000 reader is equipped with three LED indicators on its front panel. These indicators are used for signalling current states of the reader. Particular LED indicators can be activated by means of reader's inputs. In such case, master device by its outputs connected to RFT1000 inputs (see fig. 2 or 3) can activate indicators as needed. Additionally it is possible to configure behaviour of reader's indicators in particular situations. More information on configuration of LED indicators is given in par. 4.3 Configuration of inputs and LED indicators

Symbol	Name	Colour	Description
	STATUS	Red/Green	By default the indicators illuminates in red. Functioning of the indicator is programmable.
	OPEN	Green	This indicator is usually used for signalling access granting. Functioning of the indicator is programmable.
	SYSTEM	Orange	This indicator is used mainly for signalling following system errors: <ul style="list-style-type: none"> <li>• microcontroller memory failure (steady light). In such case, firmware upload or device repair is required</li> <li>• configuration error (2 Hz flashing light). In such case memory reset (restoring of default settings) is required</li> <li>• fingerprint scanner failure (10 Hz flashing light)</li> <li>• two low supply voltage (0,5 Hz flashing light)</li> </ul>

## 3.3 Power supply

RFT1000 reader requires 12 VDC supply voltage. The supply must be connected to +12V terminal and GND terminal. The GND terminal is also reference potential for RS485 bus and IN1, IN2 input lines.

All devices, which are connected to the same RS485 bus should have common ground (GND). In order to ensure this, all GND terminals of various power supply units in the system must be connected with each other using separate wire. Alternatively, the common negative pole (GND) of the entire system can be earthed, but only in single point.

## 3.4 Inputs

RFT1000 reader is equipped with two, NO type inputs (IN1 and IN2), which are activated by connection to negative supply pole. Input lines can be configured by means of RogerVDM software so they could be used for activation of LED indicators and/or buzzer in RFT1000 as well as for switching card reader mode. More information on configuration of inputs is given in section 4.3 Configuration of inputs and LED indicators.

### 3.5 Wall mounting

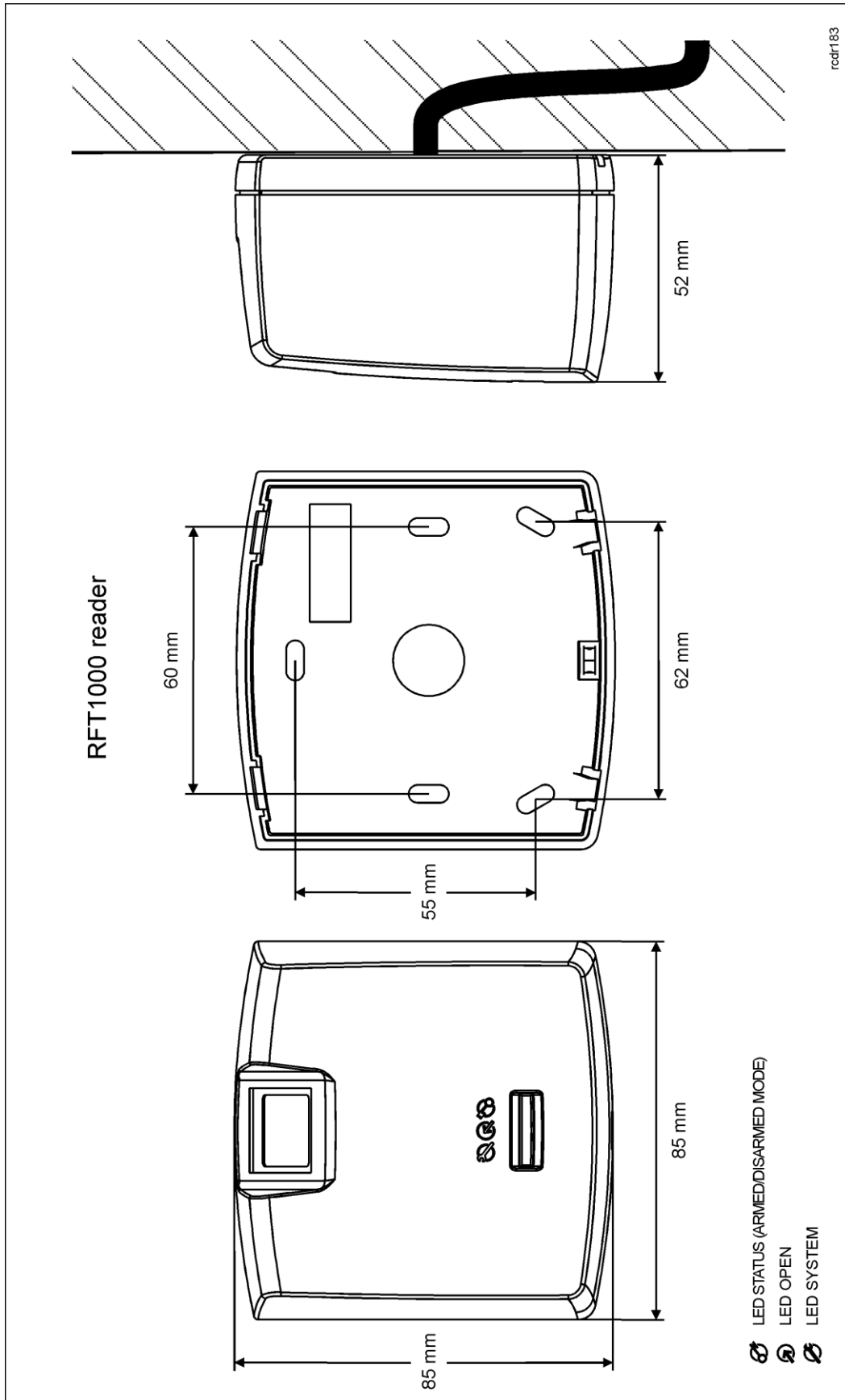

Fig. 4 RFT1000 installation

### 3.6 Use/installation guidelines

- All electric cables must be connected to devices with disconnected power supply.
- If the range of card reading is significantly lower than specified in technical documentation then consider relocation of reader.
- After installation of RFT1000 reader, remove protector from fingerprint scanner. Otherwise it may hinder fingerprint scanning.
- In case of connection through Ethernet port, twisted pair cable should be uninsulated in the shortest possible distance and wires should remain twisted in the longest possible distance.
- In order to ensure correct operation of the reader it is necessary to clean fingerprint scanner regularly by means of wet cloth and mild detergent. Do not clean by means of abrasive materials and strong cleaners like alcohols, solvents, etc. Damages to scanner surface are beyond the scope of warranty.
- RFT1000 reader should be installed in shaded and dry place, far from heat and moisture. It is necessary to avoid dust and abrupt temperature changes. The reader cannot be installed in placed exposed to direct sunlight. In the event of exposure of the device to direct sunlight or strong artificial light it may operate improperly.
- In case of communication with RFT1000 reader by means of RS485 bus it is forbidden to apply UT-4 v2.0, UT-4DR or any other Ethernet-RS485 converters.
- Proper finger placing for the purpose of fingerprint reading is shown in fig. 5. In case of kids (small fingerprints) it is recommended to verify fingerprint reading prior to installation of RFT1000.

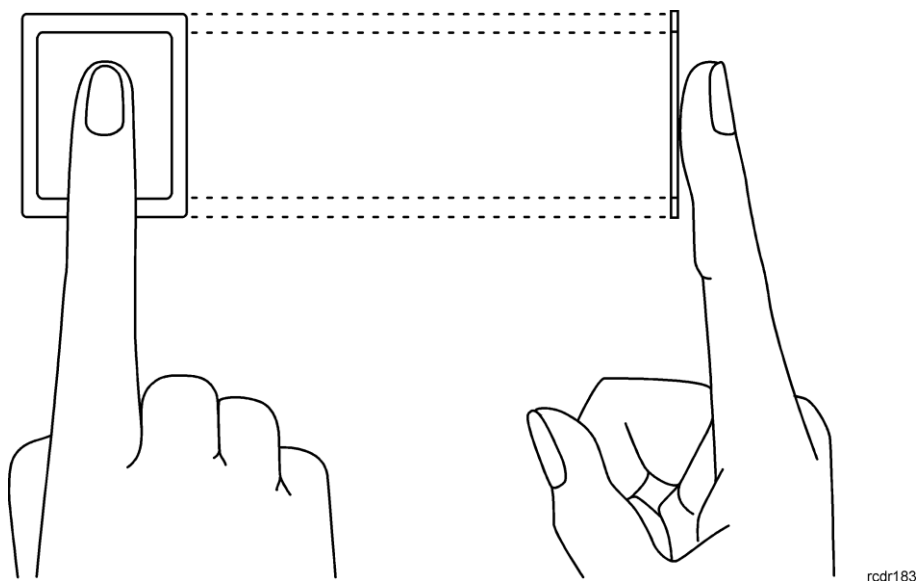

Fig. 5 Proper placing of finger on optical scanner

## 4. CONFIGURATION

The configuration of RFT1000 reader in Wiegand mode consists in:

1. Connection of the reader to network through Ethernet port according to fig. 2. or through RS485 port according to fig. 3. By default, RFT1000 is configured for Ethernet communication.
2. Installation of RogerVDM software, establishing connection with the reader and performing preliminary setup including readers's communication password.
3. Connection of the reader to master device (controller) by means of Wiegand interface according to fig. 2. Optionally, reader's inputs can be connected to master device outputs and configured.
4. In case of 1:N recognition mode, enrolment of users including their fingerprint templates and card numbers.
5. In case of 1:1 recognition mode, enrolment of users including their card numbers and then formatting their MIFARE Classic cards and recording fingerprint templates.
6. Sending the configuration to the reader.



## 4.1 Connection and configuration of communication with reader

In order to connect and configure RFT1000 reader it is necessary to know its communication parameters. Factory default settings are as follows:

- IP address = 192.168.0.70
- Subnet mask = 255.255.255.0
- Port = 13544
- Communication is encrypted with default (empty) password

It is assumed that mentioned above parameters will be changed in particular access control installation, specifically IP address, port and communication password. These parameters can be modified with RogerVDM software, which is available for download at [www.roger.pl](http://www.roger.pl).

---

Note: In order to connect with reader in local area network (LAN), the computer with RogerVDM software must be in the same subnet. In case of RFT1000 with default IP address, the IP address of computer should be 192.168.0.xxx.

---

### Procedure for establishing connection with factory new reader

1. Connect the reader to the computer by means of Ethernet port.
2. Install and start RogerVDM software.
3. In the top menu of RogerVDM select **Device** and then **New**.
4. In the newly opened window (see fig.6) select **RFT1000 v1.0** device, firmware version **1.2** and then **Ethernet** communication channel.
5. IP address and port of RFT1000 reader is automatically detected by RogerVDM software if the reader and PC with RogerVDM are in the same subnet and communication between them is not blocked. Default IP address of the reader is 192.168.0.70 and port is 13544, while communication passwords is empty.
6. Select **Connect** button.

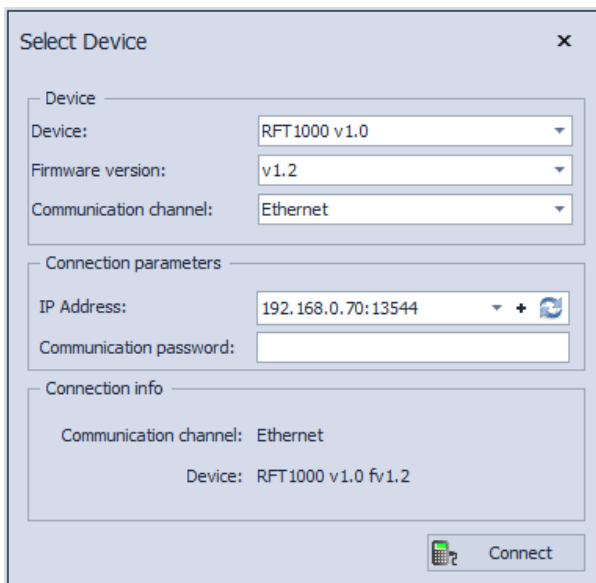

Fig. 6 Connection with RogerVDM software

After establishing the connection it is possible to modify communication parameters both for Ethernet and RS485 communication in the newly opened window, which can be accessed by selecting the option **Configuration** in the top menu. In the area **General settings** (see fig. 7) enter your settings and then upload the configuration to the reader by means of **Send to device** button.

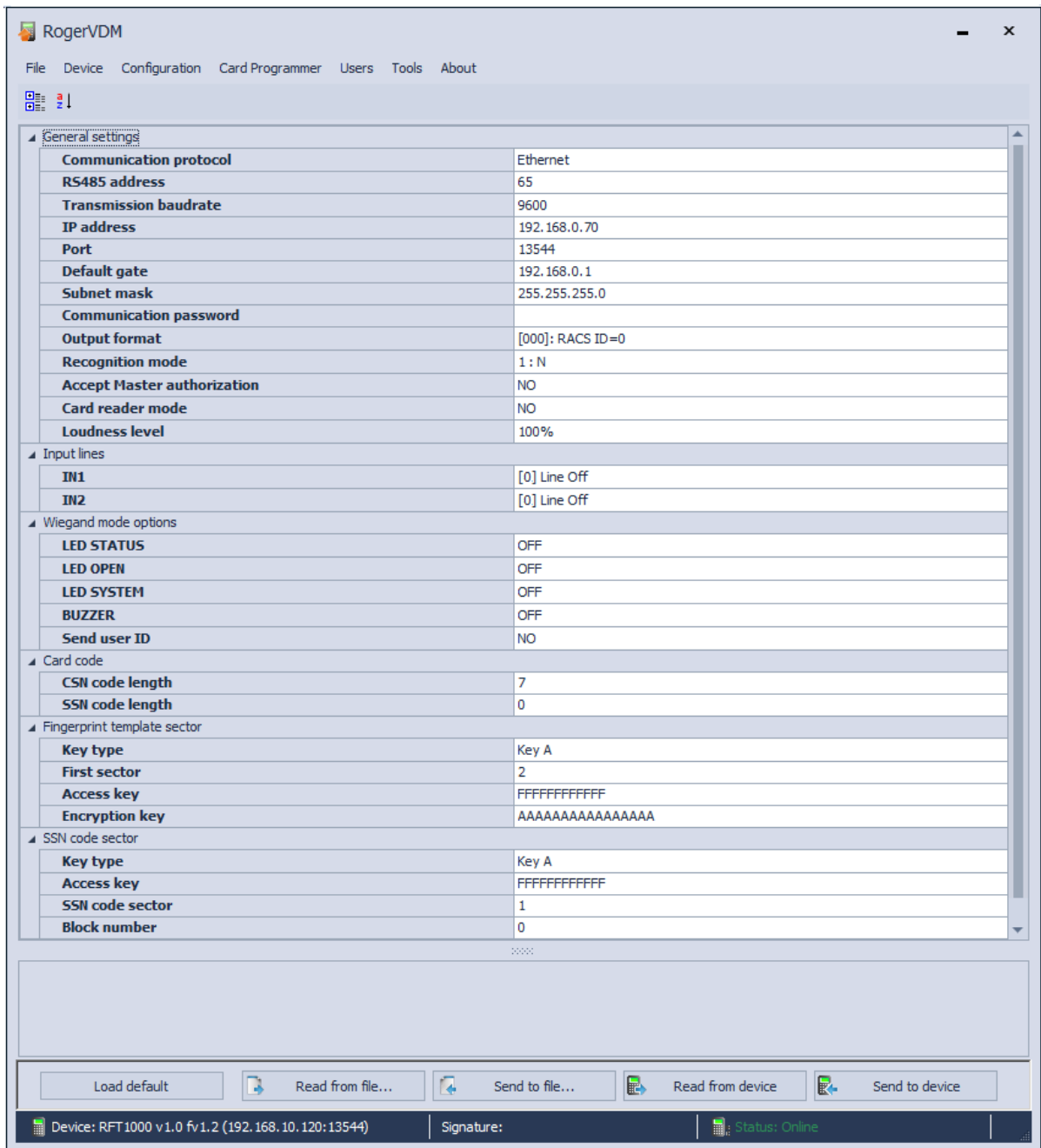

Fig. 7 Configuration window in RogerVDM software

## 4.2 Wiegand interface

RFT1000 reader can operate with all kinds of master devices if they are equipped with Wiegand interface. After proper connection in accordance with fig. 2, there must be executed configuration of connection both on RFT1000 side and master device side.

In order to configure the reader, select the option **Configuration** in the top menu of RogerVDM software and then in the area **General settings**, in the field **Output format** select required Wiegand format. The same Wiegand format must be also configured in master device. Binary data are sent by RFT1000 in Wiegand format.

## 4.3 Configuration of inputs and LED indicators

RogerVDM software enables configuration of inputs and LED indicators in RFT1000 reader. Related options are available in areas **Input lines** and **Wiegand mode options**, which can be displayed by means of the option **Configuration** in the top menu of RogerVDM software (see fig.

7). According to fig. 2, master device can control LED indicators and buzzer in the reader by means of input lines (IN1, IN2). Additionally it is also possible to switch Card Reader Mode by means of reader's input.

In general, input functions of Roger devices depending on assigned functions can be momentary or constant type. Therefore device may detect only activation of input (momentary type) or activation and deactivation of input (constant type).

<b>Table 3. Input functions</b>			
No.	Function	Type	Description
[0]	Line off	-	Input line is not used.
[1]	LED STATUS	Constant	When the input is activated then LED STATUS is green and when the input is deactivated then the indicator is red.
[2]	LED OPEN	Constant	When the input is activated then LED OPEN is on (green).
[3]	LED SYSTEM	Constant	When the input is activated then LED SYSTEM is on (orange).
[4]	BUZZER	Constant	When the input is activated then reader's buzzer generates acoustic signal.
[5]	Card Reader Mode	Constant	Functioning of input line with function [5] depends on selected recognition mode. More information on recognition mode is given in section 4.4 Recognition modes In case of 1:N recognition mode: <ul style="list-style-type: none"> <li>• when the input is activated then RFT1000 can scan fingerprints and read proximity cards</li> <li>• when the input is deactivated then RFT1000 can only scan fingerprints</li> </ul> In case of 1:1 recognition mode: <ul style="list-style-type: none"> <li>• when the input is activated then fingerprint scanner is off and user can identify only by means of proximity card</li> <li>• when the input is deactivated then RFT1000 requires proximity card and then when LED OPEN pulsates also fingerprint scan</li> </ul>

Additionally according to table 3, in the area **Wiegand mode options** (see fig. 7) it is possible to configure the reaction of LED indicators and buzzer for certain actions performed by the reader.

<b>Table 3. Internal functions of LED indicators and buzzer</b>	
Name	Function
OFF	Indicator/buzzer is all the time off
ON	Indicator/buzzer is all the time on
Short signal upon finger read	Short acoustic signal (0.2 sec) after fingering read
Long signal upon finger read	Long acoustic signal (1 sec) after fingering read
Short signal upon user recognition	Short acoustic signal (0.2 sec) after successful identification of user

Long signal upon user recognition	Long acoustic signal (1 sec) after successful identification of user
-----------------------------------	--

## 4.4 Recognition modes

RFT1000 reader can operate in two recognition modes, which are selected by means of the option **Recognition mode** in the **General settings** area of the window opened with the option **Configuration** in RogerVDM software (see fig. 7).

### 4.4.1 Mode 1:N

In 1:N mode, list of users is recorded in RFT1000 memory. Each user should have his ID number, card number, and 1 to 10 fingerprint templates. The identification of user in 1:N mode consists in reading his fingerprint or card number by RFT1000. In case of successful recognition, user card number or user ID number is send to master device by means of Wiegand interface. If user ID number is to be sent instead of his card number then the option **Send user ID** must be activated in the area **Wiegand mode options** (see fig. 7). In such case, master device must be properly configured in order to identify such ID numbers.

### 4.4.2 Mode 1:1

In 1:1 mode, fingerprint templates are recorded in memory of MIFARE Classic cards instead of RFT1000 memory. The identification of user in 1:1 mode consists in comparing his fingerprint with fingerprint template stored in user's card memory.

In order to identify user in 1:1 mode, place MIFARE Classic in vicinity of reader (LED OPEN shall pulsate) and then put your finger on scanner. In case of successful recognition, user's card number is sent to master device by means of Wiegand interface.

If the option **Accept Master authorization** in **General settings area** (see fig. 7) is activated then users with Master attribute are not required to scan their fingerprints and they can use their cards for successful identification.

## 4.5 Users

RogerVDM software enables enrolment of users for both recognition modes. The window for user enrolment (see fig. 8) is displayed by means of the option **Users** in the top menu. In case of RogerVDM, list of users is recorded in local database and it must be uploaded to RFT1000 by means of the button **Send to device**. Current list of users can be downloaded from RFT1000 by means of the button **Read from device**.

### 4.5.1 Enrolment of users in 1:N mode

After selection of 1:N recognition mode, user enrolment consists in selection of **Add** button in **Users** area and entering his ID number, name and card number. Card number can be entered manually or read by means of built-in MIFARE reader when **Read** button is selected. In the next step it is necessary to select **Add** button in the area **Fingerprints** in order to start Fingerprint adding wizard. Proceed according to displayed messages. Each user can have 1 to 10 fingerprint templates assigned.

---

Note: It is necessary to define users with the same ID numbers and card numbers in master device (controller) connected with RFT1000 reader. In case of successful identification, either by means of card or fingerprint, user's card number is sent to master device by means of Wiegand interface so it could grant or deny the access.

---

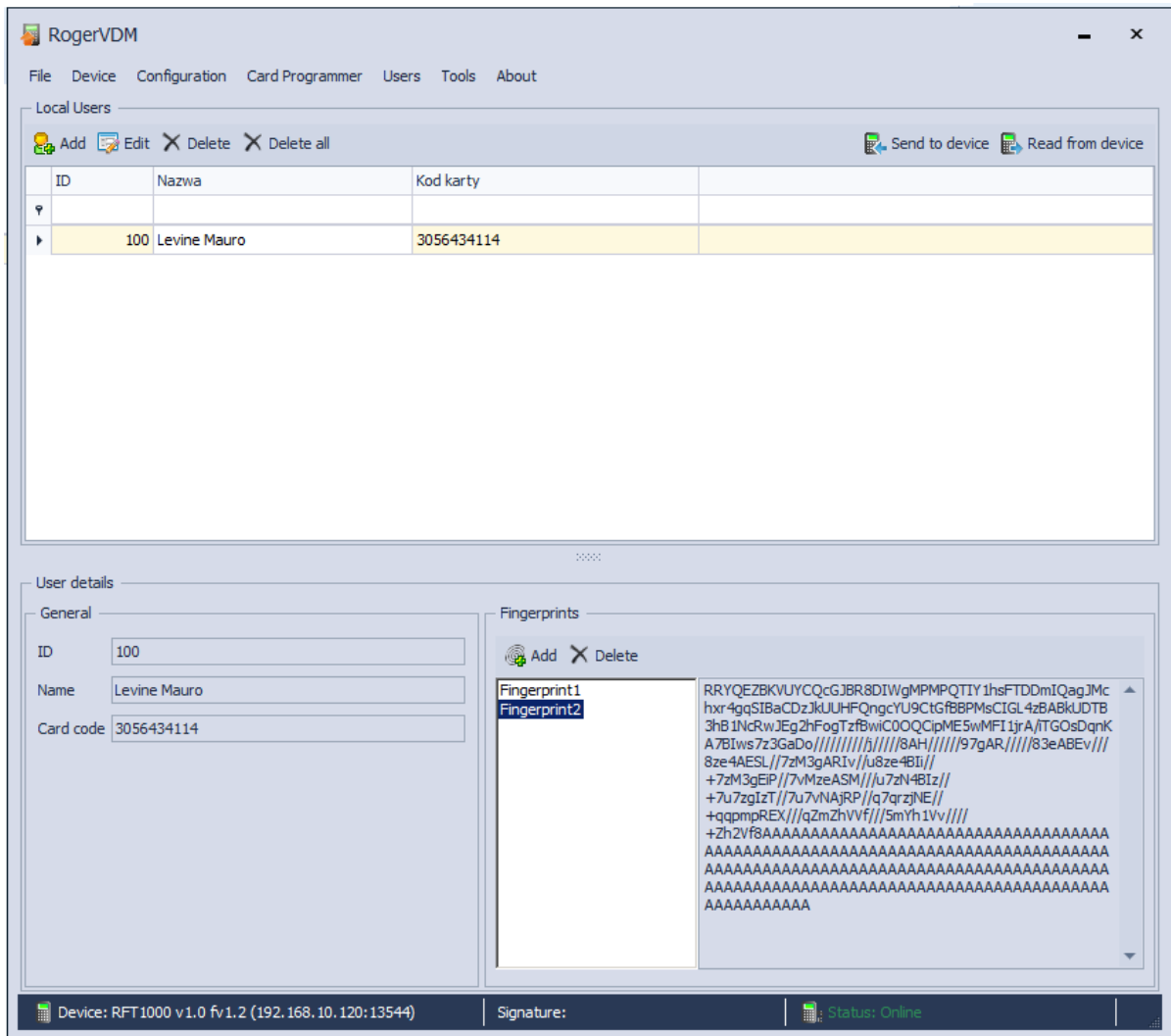

Fig. 8 User enrolment window in RogerVDM software

#### 4.5.2 Enrolment of users in 1:1 mode

After selection of 1:1 mode, user enrolment consists in selection of **Add** button in **Users** area and entering his ID number, name and card number. Card number can be entered manually or read by means of built-in MIFARE reader when **Read** button is selected. In the next step it is necessary to open the window for card programming by means of the option **Card Programmer** in the top menu of RogerVDM software (see fig. 9). In the newly opened window, MIFARE card can be formatted (erased) by means of the button **Format card** and then fingerprint template can be recorded in card's memory by means of the button **Save template**. After selection of **Save template** button Fingerprint saving wizard is started and it is required to proceed according to displayed messages. The operation can be repeated and successive fingerprint templates can be recorded until card memory is full. In the last step of the wizard the parameter **User with Master attribute** can be selected and users with such attribute are not obliged to scan their fingerprints for all RFT1000 readers with **Accept authorization master** option in **General settings area** (see fig. 7) activated. For such user, card number is sufficient for his identification. It is also possible to define sectors in MIFARE Classic memory cards, where fingerprint templates are to be recorded. Related options are available in the configuration window in the area **Fingerprint template sector** (see fig. 7):

- **Key type** – enables selection of two available access keys for card memory sectors
- **First sector** – defines first sector of card memory, where fingerprint templates are to be recorded
- **Access key** – defines access key for card memory sectors

- **Encryption key** – defines key for additional securing of data stored in memory card sectors

Note: Options in the area **Fingerprint template sector** define both the method for recording fingerprint templates during card programming and method for card reading by particular RFT1000 reader during user identification. Therefore it is necessary to ensure that in both cases i.e. card programming and user identification, mentioned settings are the same.

Note: MIFARE cards have different capacities. MIFARE Classic 1k cards can store 1 fingerprint template, while MIFARE Classic 4k card can store up to 7 fingerprint templates. MIFARE Ultralight cards do not have enough memory to store any fingerprint template.

Note: Number of the card with fingerprint templates, number of the card assigned to user in RogerVDM software and number of user's card in the master device must be the same. In case of successful identification of particular user, his card number is sent to master device (controller) by means of Wiegand interface so it could grant or deny the access.

Note: In case of RFT1000 with firmware 1.2 or newer, default **First sector** was changed to 2 and default **Encryption key** was changed to AAAAAAAAAAAAAAAAAA. This must be taken into account by administrators who want to upgrade their RFT1000 readers with newer firmware and want to use previously configured proximity cards in 1:1 recognition mode.

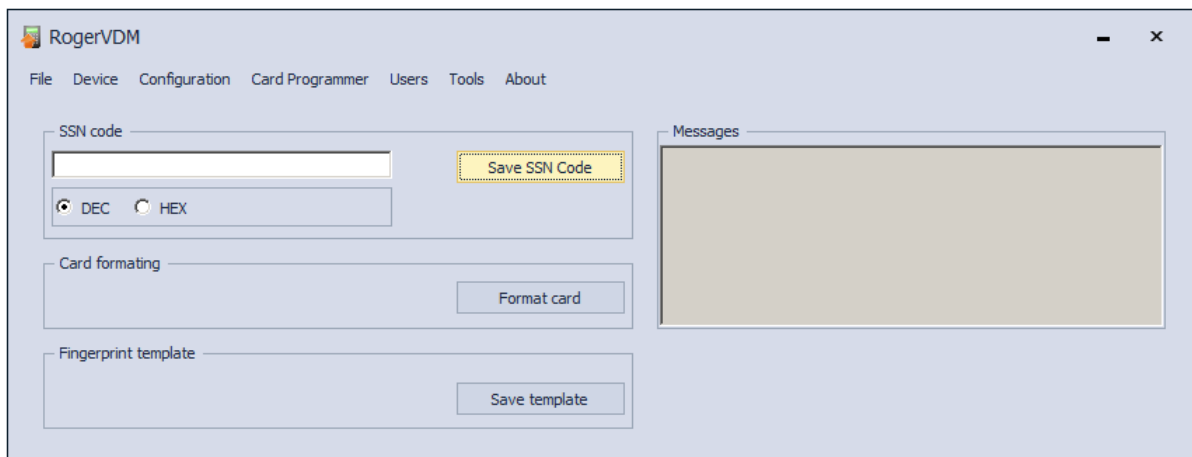

Fig. 9 Card programmer window

### 4.5.3 User identification

User identification by configured RFT1000 reader depends on selected recognition mode (see section 4.4), input with function **[5]: Card Reader Mode** (see section 4.3) and option **Card reader mode** (see fig. 7). Input **[5]** is used for dynamic switching of user identification method in such way that it depends on input state. More information on application of the input **[5]** is given in table 4 below. The option **Card Reader Mode** is applicable only for 1:N recognition mode and it enables permanent activation of card reader in RFT1000. When this option is selected then user can identify by means of card or fingerprint template as needed.

Options and functions of RogerVDM enable detailed and variant configuration of user identification method. But there can be distinguished following, most often applied settings:

- 1:N recognition mode, **[5]** input is not used, **Card Reader Mode** option inactive – user is identified only by fingerprint templates recorded in RFT1000 memory
- 1:N recognition mode, **[5]** input is not used, **Card Reader Mode** option is active – user can identify by means of fingerprint template recorded in RFT1000 memory or by means of his MIFARE card as needed
- 1:1 recognition mode, **[5]** input is not used, **Card Reader Mode** option is inactive – user must at first use his MIFARE card with his fingerprint templates and then he must place his finger on RFT1000 scanner

<b>Table 4. User identification by RFT1000 with [5] input.</b>		
Recognition mode	Card Reader Mode	User identification
1:N	Input with the function [5] deactivated	Place finger on RFT1000 scanner.
1:N	Input with the function [5] activated	Place finger on RFT1000 scanner or read proximity card.
1:1	Input with the function [5] deactivated	Place your MIFARE proximity card in vicinity of RFT1000 reader and when LED OPEN (green) flashes, place your finger on RFT1000 scanner. User's card does not have to be in vicinity of reader when LED OPEN pulsates. Users with Master attribute can use their cards and they do not have to scan their fingerprints in order to get access.
1:1	Input with the function [5] activated	Read proximity card.

## 4.6 Card code

MIFARE Classic and MIFARE Ultralight cards have their read-only serial numbers called CSN and memory, where administrator defined number called SSN can be stored. Optional SSN code provides additional security as it can be saved in administrator defined sector and it can be protected with access code against unauthorized reading. RogerVDM software enables defining of SSN code and recording it to any available sector of MIFARE card memory. RFT1000 reader can identify particular card (user) by means of CSN code, SSN code or combination of both but the total number cannot exceed 11 bytes. Options related to reading of CSN and SSN codes are available in **Card code** area of reader configuration window (see fig. 7)

*Example:*

*Default settings of RFT1000 reader in Card code area is as follows: CSN code length = 7, SSN code length = 0. In case of such settings, the RFT1000 reads 7 bytes of CSN code only. In case of exemplary settings: CSN code length = 4, SSN code length = 4, RFT1000 reader during card identification would read code consisting of 4 bytes of CSN code and 4 bytes of SSN code.*

### 4.6.1 SSN code programming

SSN code as opposite to CSN code of MIFARE card can be defined by administrator. SSN Code as well as its sector in memory and method for recording can be indicated by administrator. SSN code can be defined and recorded by means of RogerVDM options, which are available in the area **SSN code** in the **Card programmer** window (see fig. 9). After selection of **Save SSN code** button it is necessary to hold the card in vicinity of RFT1000 reader. The code can be entered in decimal or hexadecimal format. Location and recording method can be defined by means of options, which are available in the area **SSN code sector** (see fig. 7):

- **Key type** – enables selection of two available access keys for card memory sectors
- **Access key** – defines access key for card memory sectors
- **Sector** – defines sector of card memory, where SSN code is to be recorded
- **Block number** – defines block number of card memory where SSN code is to be recorded

Note: Options in the area **SSN code sector** define both the method for SSN code recording during card programming and method for SSN code reading by particular RFT1000 reader during user identification. Therefore it is necessary to ensure that in both cases i.e. card programming and user identification, mentioned settings are the same.

## 4.7 Configuration export/import

RogerVDM software enables saving the configuration of RFT1000 to file and reading of such configuration from file. Such file can be protected with password.

The option **Send to device...** on reader configuration window (see fig. 7) enables exporting of RFT settings excluding users data base, while the option **Send configuration to file** which is available after selection of **File** option in the top menu of RogerVDM software enables exporting of RFT1000 full configuration including users data base. Following options are used respectively for reading configuration: **Read from device** (see fig. 7) and **Read configuration from file**, which is available by selection of File option in the top menu of RogerVDM software.

## 4.8 Encrypted communication

The communication with RFT1000 reader both in case of Ethernet and RS485 port can be encrypted with AES128 CBC standard. By default, encryption is conducted with empty communication password. Administrator can define his own communication password (max. 16 digits) in reader configuration window in the field **Communication password** (see fig. 7). Such password must be then entered when establishing connection with the reader by means of RogerVDM (see fig. 6).

## 4.9 Full memory reset

Full memory reset erases current settings, including users data base and restores factory default settings. Reset method must be selected depending on target communication method with the reader (Ethernet or RS485).

### **Reset procedure (communication channel – Ethernet):**

- Switch off power supply to RFT1000.
- Remove connections to CLK and IN2 terminals.
- Connect CLK terminal with IN2 terminal.
- Switch on power supply to RFT1000. The reader shall generate continuous acoustic signal.
- Disconnect CLK and IN2 terminals.

Communication parameters after reset:

- IP address = 192.168.0.70
- Subnet mask = 255.255.255.0
- Port = 13544
- Communication is encrypted with default (empty) password

### **Reset procedure (communication channel – RS485)**

- Switch off power supply to RFT1000.
- Remove connections to CLK and IN1 terminals.
- Connect CLK terminal with IN1 terminal.
- Switch on power supply to RFT1000. The reader shall generate continuous acoustic signal.
- Disconnect CLK and IN1 terminals.

Communication parameters after reset:

- RS485 address= 65
- Transmission baud rate = 9600
- Communication is encrypted with default (empty) password

---

Note: Because of relatively high current consumption of RFT1000, it cannot be supplied by means of RUD-1 communication interface and use of external power supply unit is necessary. In case of connection by means of RS485 port it is also necessary to connect GND of power supply unit with GND of RS485 communication bus.

---



## 4.10 Firmware update

Firmware update is performed by means of RogerVDM software and the recommended communication channel is Ethernet port. In order to update the firmware after establishing connection with RFT1000:

1. Select the option **Tools** in the top menu of RogerVDM software and then select **Update firmware**
2. In the newly opened window select RFT1000 firmware file (\*.frg extension) by means of the button **Select file**
3. Select the button **Update** in order to upload the firmware to RFT1000

RFT1000 keeps all its settings (including IP address) after firmware update.

## 5. ORDERING INFORMATION

Table 5 Ordering information	
Product	Description
RFT1000	Fingerprint and MIFARE Ultralight/Classic proximity card reader.
MFC-2	13.56 MHz MIFARE Classic ISO size thin PVC card, 1k bytes memory.
MFC-3	13.56 MHz MIFARE Classic ISO size thin PVC card, 4k bytes memory.

## 6. PRODUCT HISTORY

Table 6 Product history		
Product version	Released	Description
1.0	06/2013	The first commercial version of the product
1.1	12/2013	Built-in antenna modifications

	<p>This symbol placed on a product or packaging indicates that the product should not be disposed of with other wastes as this may have a negative impact on the environment and health. The user is obliged to deliver equipment to the designated collection points of electric and electronic waste. For detailed information on recycling, contact your local authorities, waste disposal company or point of purchase. Separate collection and recycling of this type of waste contributes to the protection of the natural resources and is safe to health and the environment. Weight of the equipment is specified in the document.</p>
---	---

**Contact:**  
**Roger sp. z o.o. sp.k.**  
**82-400 Sztum**  
**Gościszewo 59**  
**Tel.: +48 55 272 0132**  
**Fax: +48 55 272 0133**  
**Tech. support: +48 55 267 0126**  
**E-mail: [support@roger.pl](mailto:support@roger.pl)**  
**Web: [www.roger.pl](http://www.roger.pl)**